

datavideo

4K UHD

 CAST mini

4K Dual Channel  
Presentation Switcher



[www.datavideo.com](http://www.datavideo.com)





**4K UHD**

# Dual Channel Presentation Switcher

## Improve the quality of your online presentations!

Datavideo's iCAST mini is a multimedia device designed for single-operator applications. From small scale corporate training sessions to mid-sized hybrid classrooms or conference halls, the iCAST mini is the perfect fit for your online presentation needs. With the one-button-one-function feature on a unique and easy to use touch panel control, even novice users will be able to operate this device. You don't need to learn complicated technologies about video production or hire a professional production team. You can take control of your own presentations with the iCAST mini. Simply connect the power and the video sources, then leave the rest to the iCAST mini.



## Control Panel

Home



## Rear Panel

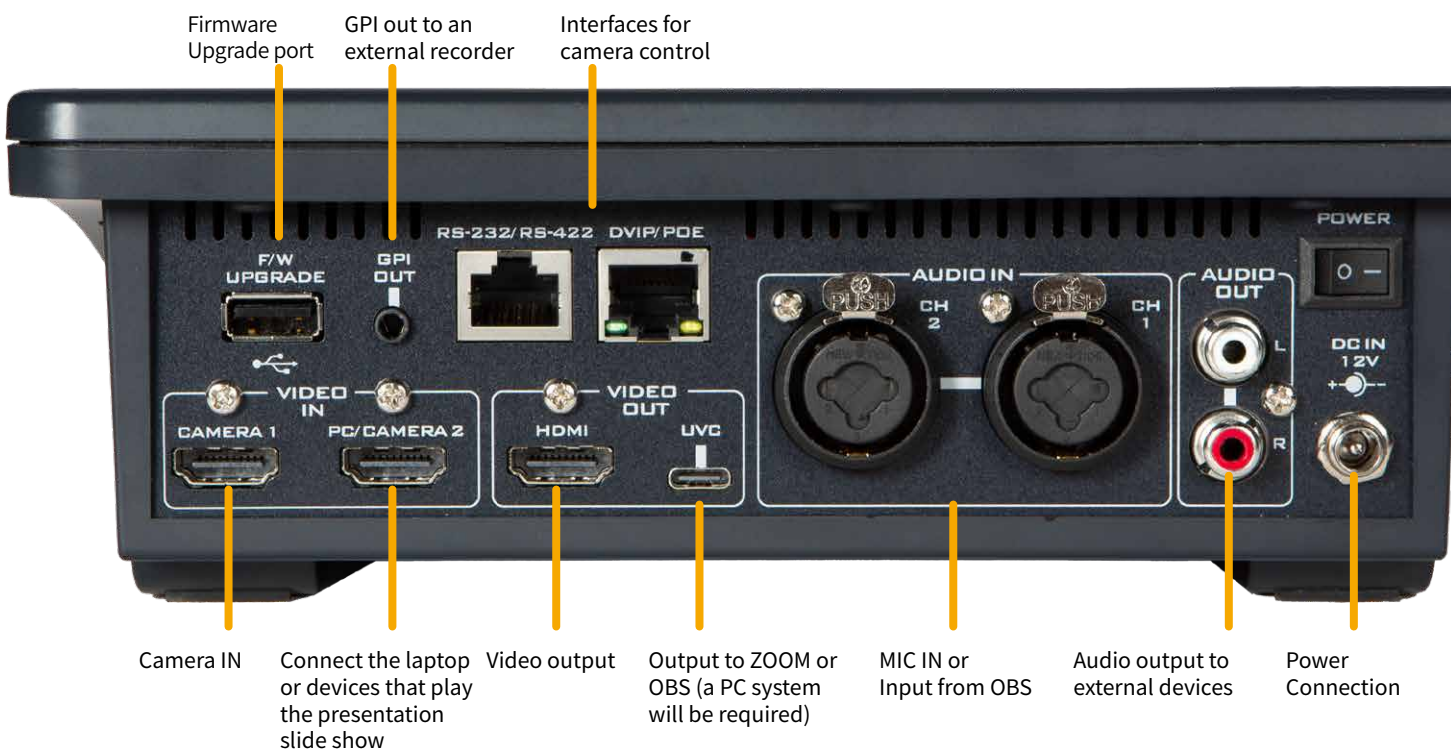

### Camera Control



### PIP Settings

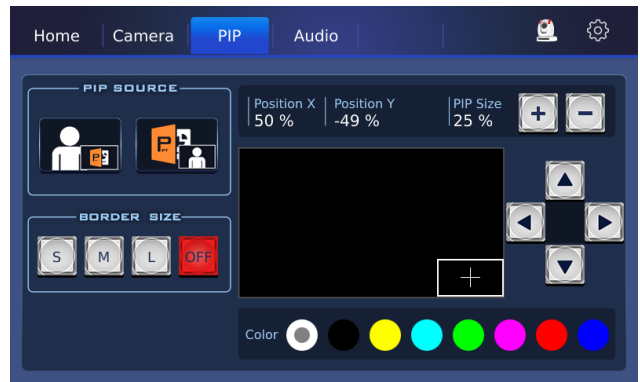

### Audio Settings



### System Settings

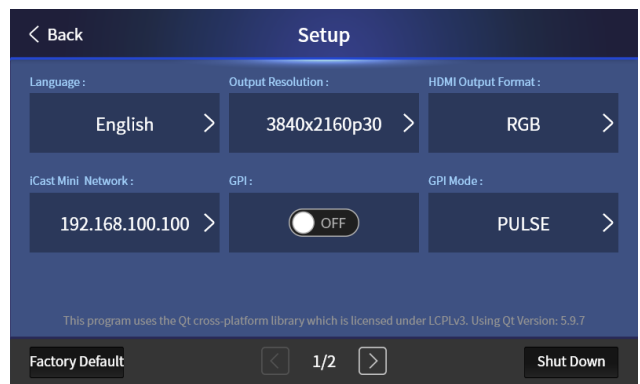

Output to headphones or stereo speakers

## Small to mid-sized meetings



### Small to mid-sized meetings

Small to mid-sized meetings require an easy-to-use device that is readily accessible to all presenters. The iCAST Mini's PIP function allows display of meeting contents as well as the image of the speaker so that the information can be clearly and correctly conveyed to the audience.

### Corporate Training

Corporate training rooms rely heavily on peripheral devices. Most traditional training sessions are conducted using a laptop connected directly to a large display, the presenter is unable to switch between their presentation, training material or a camera for the benefit of an online audience.

Traditional switchers are designed with video production professionals in mind, they can be complicated to setup and operate. The iCAST mini's intuitive touch screen interface is specifically designed to allow any user to easily switch between different views of training contents allowing the user to focus on their presentation without worrying about the production.

# Corporate training



# Hybrid Classroom



## Hybrid Classroom

In the recent years, traditional classroom teaching has encountered significant changes. It is not only about conveying information in a classroom, you must also get your information across an online audience.

The iCast mini can output stunning 4K UHD video to a large display in the classroom as well as to all video conferencing platforms including Zoom, Microsoft Teams and Google Meet, ensuring you're in person and online audience have the same visual experience. The iCAST mini's intuitive touch screen interface and integration with the PTC 145/285 AI PTZ cameras allows the teacher to minimize interruptions and focus on the teaching.









# One USB Type C cable to merge online and offline teaching

The most used platforms for hybrid classrooms are ZOOM, Microsoft Teams, and Google Meet. Without changing the current classroom setting, the iCAST mini can deliver video and audio to any video conferencing platforms via the UVC interface with a USB type C cable. You don't need to install drivers or perform any configuration.

Watch live on the big screen



laptop to conduct

UVC to PC



HDMI



Remote participants

## Graphical User Interface on Touch Panel



An intuitive graphical user interface on a 7-inch touch panel with an anti-fingerprint protection provides you with a clear view from any angle.

## Videos and PIP Mode

Switch rapidly between your presentation and the camera input or overlay a PIP window on the program video. You can also swap between the program out video and the PIP image, thereby enhancing the quality of your presentation.

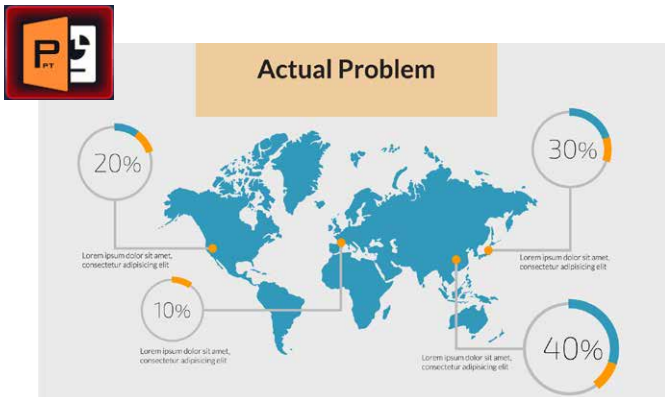

# Images for key icons for easier identification

Using a real image as your key icon allows you to easily identify the camera view that is saved in the key. You can capture camera images and save them as thumbnails which are in turn applied to icons of shortcut keys on the Home screen, simply pressing the thumbnail will send the PTZ camera to the pre-saved position.

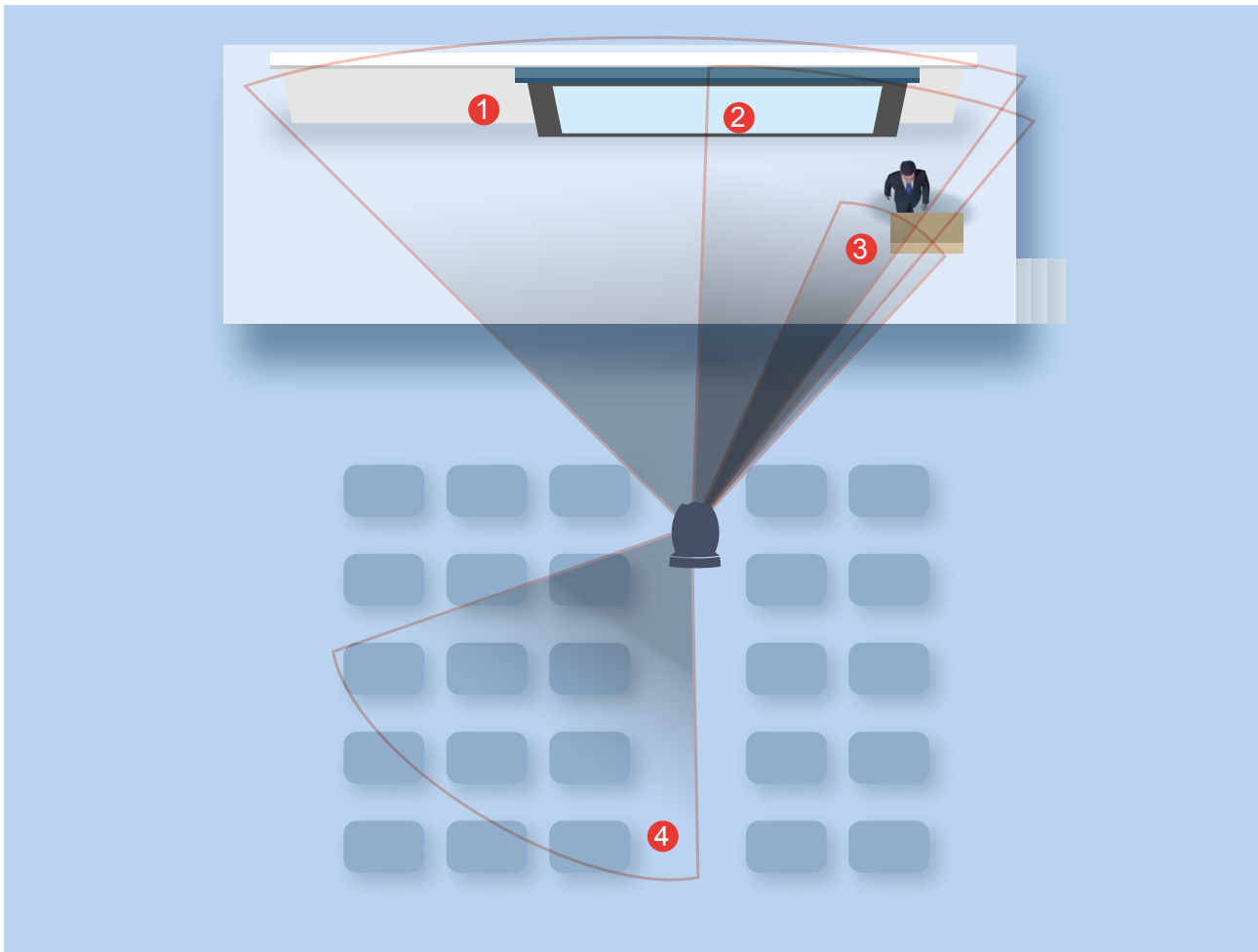
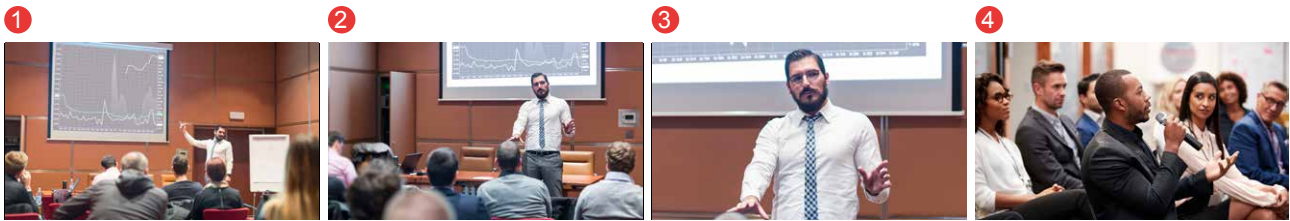

## Graphic icon for keys to simplify workflow



In addition to image keys, you can use the device's built-in graphical icons for better identification. We've pre-loaded hundreds of these icons on the device for intuitive operation.

Up to 100 icons.



## Image Key + Graphic Key

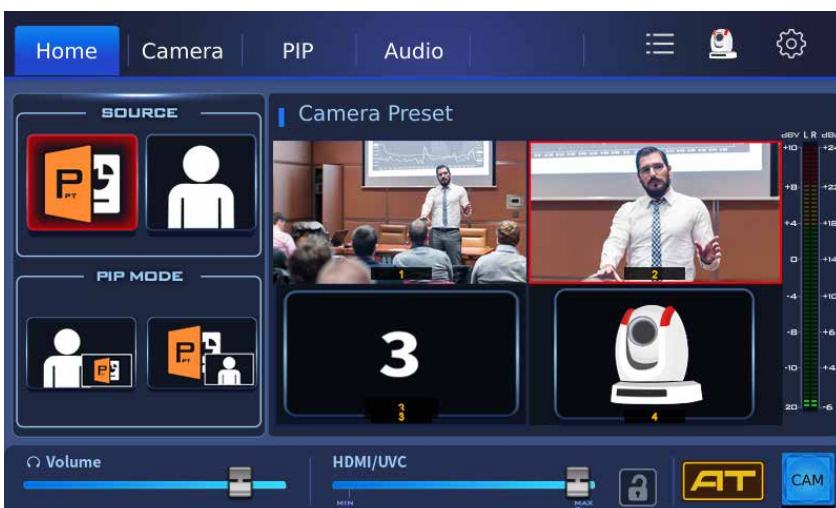

Graphical icons can co-exist with the image icons. They not only simplify your workflow but make operation faster and easier.

# You need a camera that understands your needs

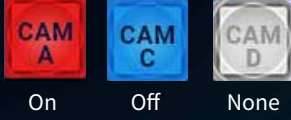

PTC-145

## Auto Tracking Mode

Automate your presentation with Datavideo's PTC-145 (HD) or PTC-285 (4K UHD) Smart Auto Tracking PTZ cameras. Your only responsibility is to create a presentation, the PTC-145/285 will capture desired images with its advanced auto tracking function.

### PTZ Cameras with Auto Tracking



Full body



Half body



Close up

Datavideo's PTC-145/285 Smart PTZ cameras allow you to switch between full body, half body and close up shots. Once the smart tracking function takes over, the camera will be able to more precisely determine the appropriate shots for your video production job.

### Using non PTZ cameras

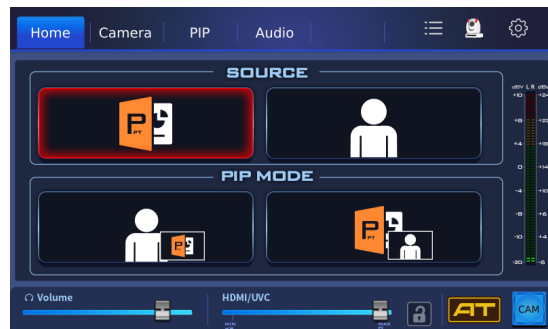

When using the iCAST mini with Datavideo's BC-15P or other non PTZ cameras, you can hide the camera presets on the UI and simply display panes that allow you to switch between camera images and presentation contents which can be swapped with PIP images. In this way, the keys are enlarged to facilitate operations.



### About auto tracking PTZ cameras

In addition to iCAST Mini, Datavideo also provides various devices that offer different degrees of control over our auto tracking on cameras. If you need to rapidly enable/disable the smart camera's auto tracking function, you can use the supplied RMC-1 remote control, RMC-300A controller, RMC-180 MARK II controller with an RS-422 interface, PTC View Assist, or TPC-700. If you would like to use a controller with a video switching function, available choices are KMU-200, SHOWCAST 100 and iCAST mini.





## Self-defined object to be auto tracked

If in your camera image, there are multiple objects, you can customize the settings such that only the target object is auto tracked by the smart AT camera. Basically, a relational model between the tracked target object and the camera will be defined so that even when noises such as desks, unnecessary objects, people, etc appear in the camera image, the AT smart tracking system will still lock onto the configured speaker or object.



## Pan, tilt and zoom the smart camera

A PID driven algorithm is able to adjust the pan, tilt and zoom tracks and speeds according to movements of the tracked object, thus mimicking smooth human operation of the lens and avoiding sudden acceleration or halt of the lens motion.



### 「For ultimate camera movement」

In order to provide smooth lens movement, Datavideo has designed a professional AI algorithm that smoothly accelerates and decelerates the lens, determines the most appropriate lens track, and avoids sudden halts upon direction reversal, ultimately bringing you professional production results.



Zoom in



Zoom out

## Camera Control



Using an Ethernet cable, you will be able to control Datavideo's PTC camera series via the RS-232/422 or DVIP interface, such as pan and tilt settings, image size, brightness, contrast, etc, making sure that the cameras always generate high quality images.

Camera control

Save up to four presets

### Adjustment of white balance, focus, iris and shutter

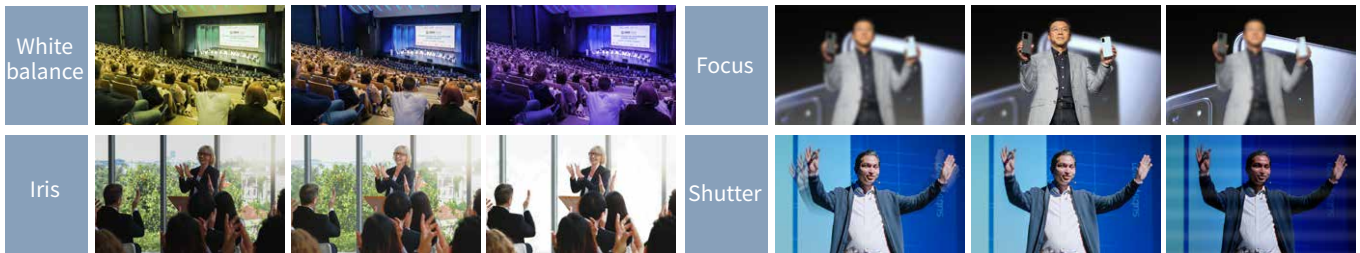

### Camera Control

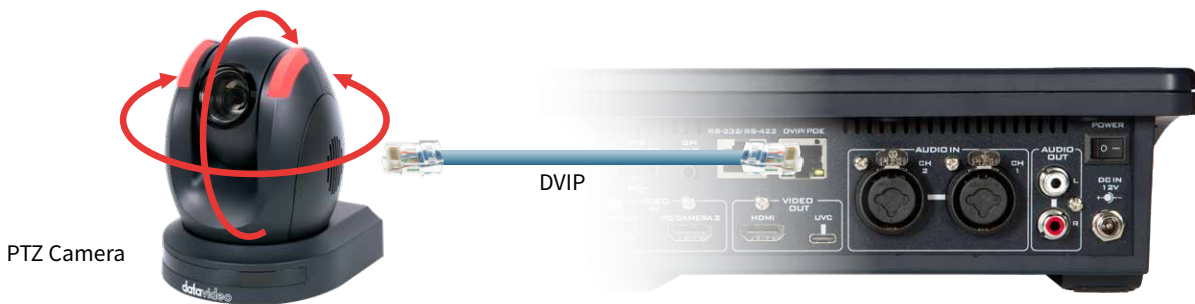

### Four camera presets



# PIP

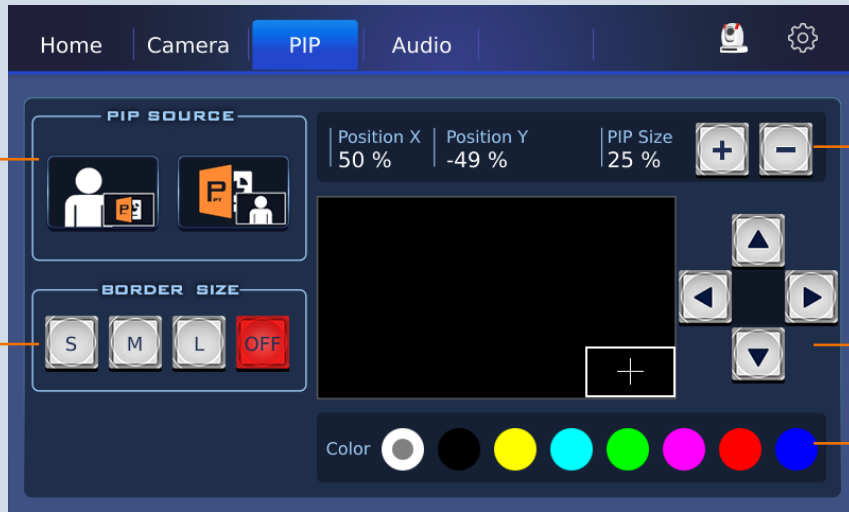

PIP video source

PIP window's size

PIP window's border size

Move the PIP window

PIP window's border color

## Set the PIP window's size and position

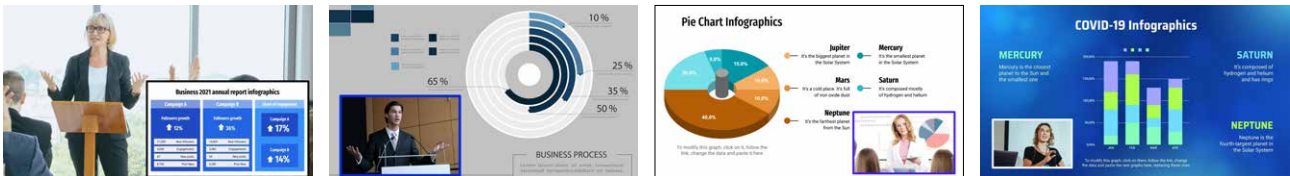

## Set the PIP window's border color

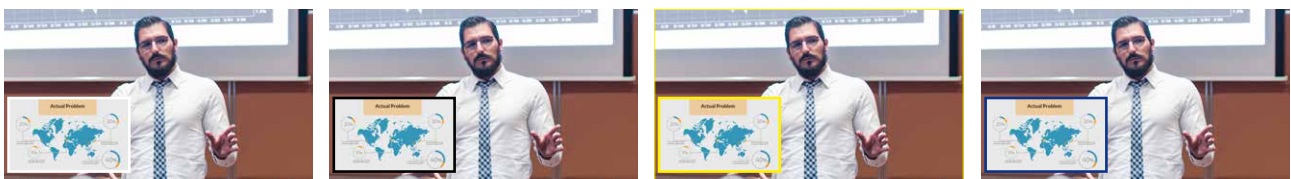

White

Black

Yellow

Blue

## Set the PIP window's border size



None

Thin

Medium

Thick

## Volume Control



Audio is an integral part of any production, and iCast mini is packed with powerful audio features. Audio mixing, mic input format setting and audio-to-video synchronization ensure your audio needs are covered.

### Audio Mixer

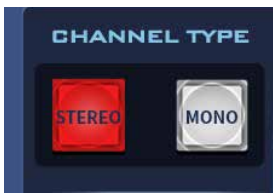

Stereo



Audio mixer

The audio mixer allows you adjust audio levels and synchronize audio from multiple multimedia sources. With the configurable channel type, you can set the audio channel to either stereo or mono for a more balanced MIC input. You can also synchronize live video and audio with the built-in audio delay function.

# System diagram

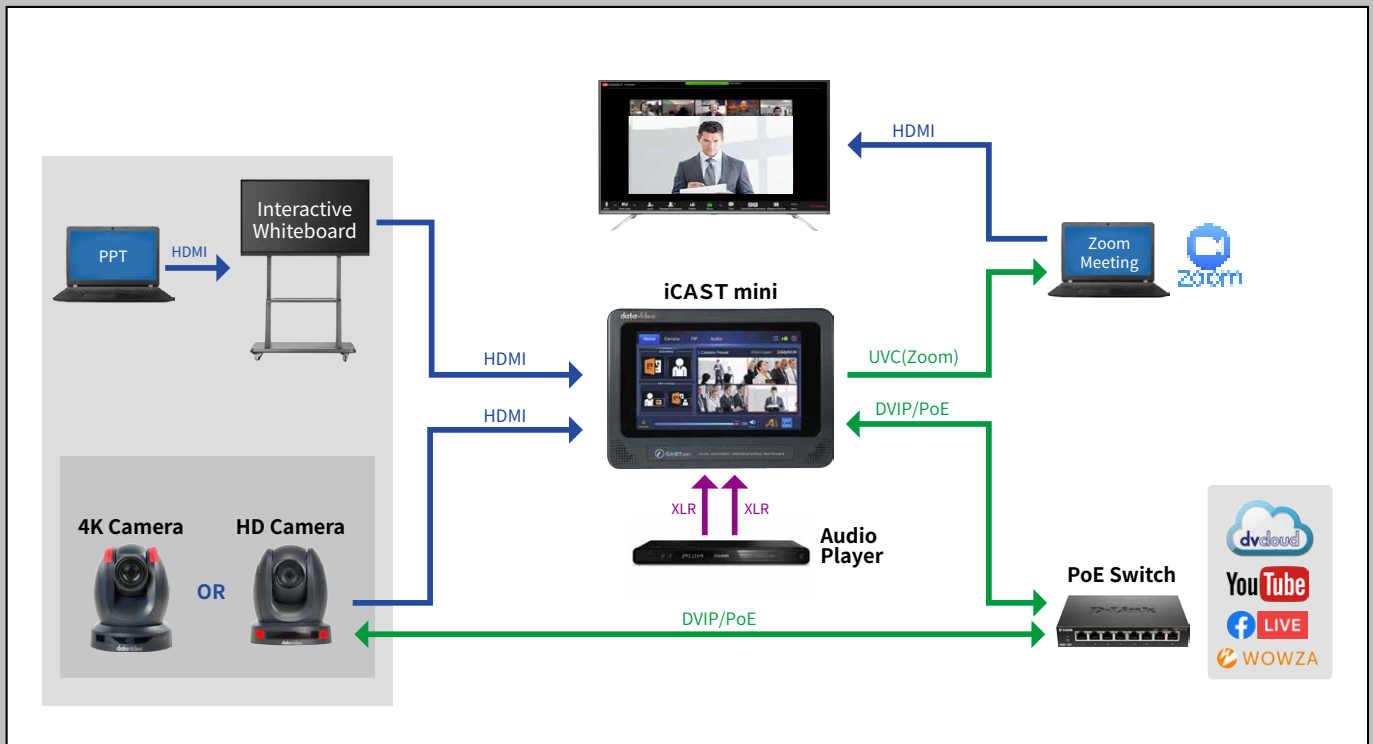

# Related Products



**PTC-140**  
HD PTZ Camera

- 1/2.8 inch CMOS sensor.
- 1920x1080px Full HD resolution, 60fps
- 20x Optical Zoom, 10x Digital Zoom
- SDI/HDMI output
- H.264/ H.265 streaming encoder
- External audio input: 3.5mm audio or line in
- Advanced 2D/3D noise reduction technology
- Compatible with various controllers: Datavideo PTZ View Assist APP, RMC-300 and RMC-180 series.



**PTC-145**  
HD Tracking PTZ Camera

- 1/2.8 inch CMOS sensor.
- 1920x1080px Full HD resolution, 60fps
- 20x Optical Zoom, 8x Digital Zoom
- SDI/HDMI output H.264/ H.265 streaming encoder
- Auto tracking object supported
- External audio input: 3.5mm audio or line in
- Advanced 2D/3D noise reduction technology
- Compatible with various controllers: Datavideo PTZ View Assist APP, RMC-300 and RMC-180 series.



**PTC-280**  
4K Camera

- Supports up to 2160p50/60 via HDMI
- 12x Optical Zoom, 16x Digital Zoom
- 1/2.5" CMOS
- Built-in H.264/H.265 dual streaming encoder
- 2160p and 1080p(3G-SDI) simultaneous video output
- External audio input: 3.5mm audio or line in
- Compatible with various controllers: Datavideo PTZ View Assist APP, RMC-300 and RMC-180 series.

## Related Products



**PTC-285**

**12x 4K Tracking Camera**

- Supports up to 2160p50/60 via HDMI 4:2:2 YUV output
- 12x Optical Zoom, 16x Digital Zoom
- 1/2.8" CMOS
- Auto tracking object supported
- Built-in H.264/H.265 dual streaming encoder
- External audio input: 3.5mm mic in or line in
- Compatible with various controllers: Datavideo PTZ View Assist APP, RMC-300 and RMC- 180 series.



**PTC-300**

**20x 4K Camera**

- Supports up to 2160p50/60 via HDMI
- 20x Optical Zoom, 16x Digital Zoom
- 1/1.8" CMOS
- Built-in H.264/H.265 dual streaming encoder
- 2160p and 1080p(3G-SDI) simultaneous video output
- External audio input: 3.5mm mic in or line in
- Compatible with various controllers: Datavideo PTZ View Assist APP, RMC-300 and RMC- 180 series.



**PTC-305**

**20x 4K Tracking Camera**

- Supports up to 2160p50/60 via HDMI
- 20x Optical Zoom, 16x Digital zoom
- 1/1.8" CMOS
- Built-in H.264/H.265 dual streaming encoder
- Auto tracking object supported
- External audio input: 3.5mm mic in or line in
- Compatible with various controllers: Datavideo PTZ View Assist APP, RMC-300 and RMC- 180 series.



**BC-15P/PN**

**4K POV Camera**

- 1/2.3" CMOS sensor with 4K 50/60p output, perfect for low light environment video production
- H.264/265 streaming encoder built-in
- Streaming videos in RTMP(S) and SRT
- support Datavideo dvCloud
- App control and live Preview
- Power over Ethernet supported
- Small box design makes it flexible to be mounted anywhere.
- Swappable Fixed Lens Built-in
- Support two types of controls: physical buttons, and APP
- NDI technology (BC-15PN)



**BC-15C/CN**

**4K CS Mount POV Camera**

- 1/2.3" CMOS sensor with 4K 50/60p output, perfect for low light environment video production
- H.264/265 streaming encoder built-in
- Streaming videos in RTMP(S) and SRT
- Support Datavideo dvCloud
- App control and live Preview
- Power over Ethernet supported
- Standard CS mount interchangeable lens design
- Supports DC-IRIS function
- Small box design makes it flexible to be mounted anywhere.
- Support two types of controls: physical buttons, and APP
- NDI technology (BC-15CN)



**PTR-10/10T MARK III**

**Robotic Pan Tilt Head**

- Turn camcorder into PTZ
- Multiple signal interface: SDI, HDMI, RS-232, RS-422, DVIP/HDBaseT, Tally, LANC
- Diversified controller options: RMC-180, RMC-300, and HS- 1600T series
- Control of Pan, Tilt, Zoom
- Support optional Datavideo ZEK-1 Zoom Encoder Kit, and ZEK-2 to detect and read out the Zoom position of cameras on top
- Max. Camera Weight 4kg

# Specification

Model Name	iCAST mini
Product Name	4K Dual Channel Presentation Switcher
Video Standard	4K & HD
Video Format	Input: 3840x2160p: 30/29.97/25/24/23.98 1080p: 60/59.94/50/30/29.97/25/24/23.98 1080i: 60/59.94/50, 720p: 60/59.94/50 525i59.94 NTSC, 625i50 PAL  Output: HDMI 3840x2160p: 30/29.97/25 1080p: 60/59.94/50/30/29.97/25/24/23.98 UVC 3840x2160p: 30/29.97/25 1080p60/59.94/50/30/29.97/25 720p60/59.94/50
Video Processing	4K2K30 4:4:4, 8bit
Input Routable / Crosspoint	N/A
Video Input	2 x HDMI 1.4
Computer Graphic Interface	2 via HDMI
Video Output	1 x HDMI 1.4 1 x USB 3.0 Type C (UVC)
Down-converted Output	Yes
Analogue Audio Input	2 x 3 Pin XLR / 1/4" (6.3mm) Combo Socket
Analogue Audio Output	1 x Stereo RCA set (L/R) 1 x Stereo headphone
Digital Embedded Audio Support	Input 2 channels, Output 2 channels
Audio Delay Calibration	Up to 170ms
A+V Switching	Yes
Picture in Picture	1
Effects	Cut
Camera Control	DVIP/ RS-422/ RS-232
Built-in Audio Mixer	Yes
Firmware Update	USB
Special Features	7" Touchscreen Display
Chassis	Unibody
Dimension (LxWxH)	220x154x75
Weight	1.1 kg
Power	DC 12V 18.7W
Operating Temp. Range	0~40 ° C
What's in the Box	1 x iCAST mini product 1 x AD Switch DC 12V with AC Cord

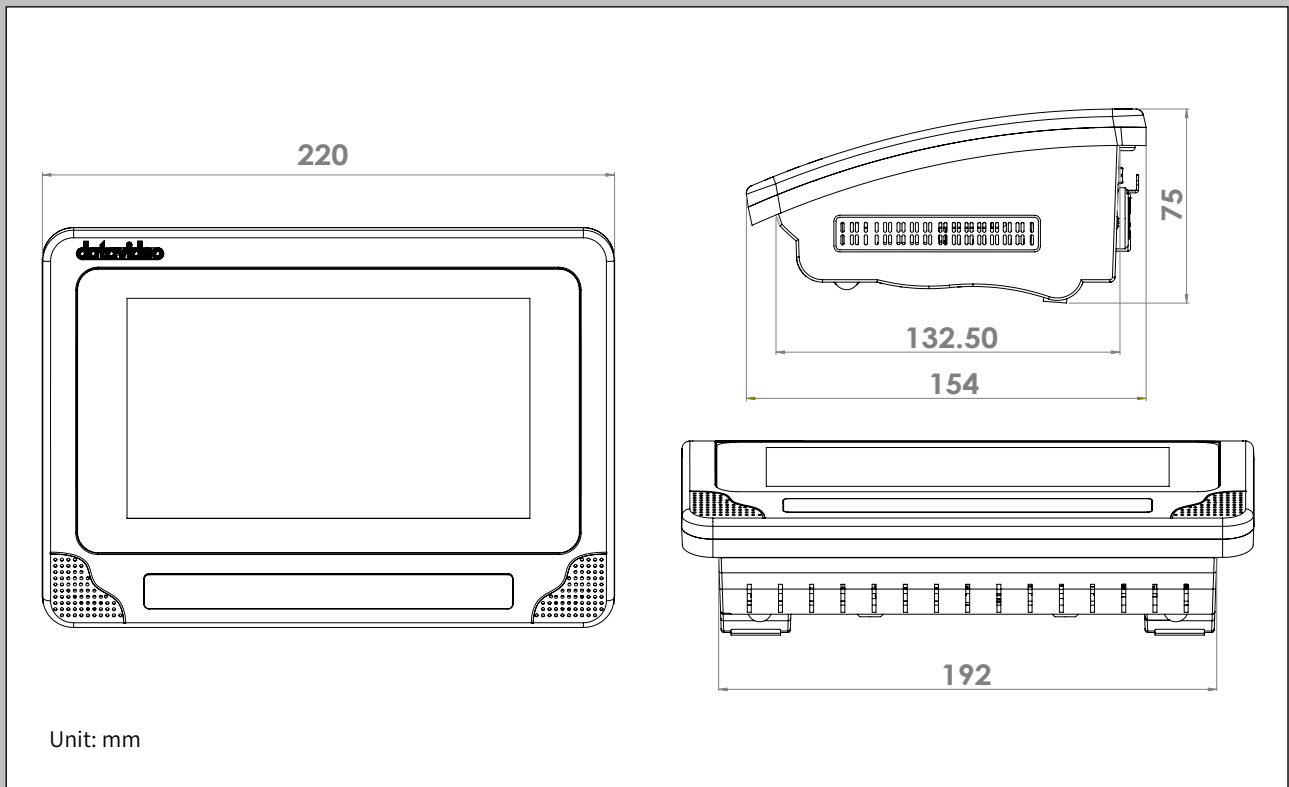



@DatavideoUSA @DatavideoAsia  
@DatavideoEMEA @DatavideoIndia2016  
@DatavideoTaiwan @Datavideojapan



@Datavideo  
@Datavideo\_EMEA  
@Datavideo\_Taiwan



@DatavideoUSA  
@DVTWDVCN



@DatavideoUSA  
@DatavideoEurope

---

#### Disclaimers of Product and Services

This brochure is intended as a guide only. We reserve the right to change specifications and availability without prior notice. While we strive for complete accuracy, be aware that it may contain errors and omissions. Prior to purchase, please check with your local Datavideo office or authorised distributor.

Ver.20230912