



# **AEQ FORUM**

**DIGITAL AUDIO MIXER  
FOR BROADCAST APPLICATIONS**

## **USER'S MANUAL ED. 01/12**

V. 1.1 - 07/05/2012  
Software version 3.21, April 2012

## CONTENTS

	Pág.
1. INTRODUCTION.....	4
1.1. General overview.....	4
1.2. Functional specifications.....	5
2. PHYSICAL DESCRIPTION OF THE UNIT.....	6
2.1. Description of the control surface.....	6
2.1.1. Channels.....	6
2.1.1.1. Routing keys.....	8
2.1.1.2. SELECT.....	8
2.1.1.3. Channel display.....	8
2.1.1.4. CUE.....	9
2.1.1.5. Indicators of active processes.....	9
2.1.1.6. ON AIR LED.....	10
2.1.1.7. Fader.....	10
2.1.1.8. Channel activation keys.....	11
2.1.2. Control and monitoring section.....	11
2.1.2.1. Control VU meters.....	12
2.1.2.2. Programmable keys.....	12
2.1.2.3. Main screen.....	13
2.1.2.4. Control room monitoring section.....	14
2.1.2.5. Studio room monitoring section.....	15
2.1.2.6. Talkback.....	16
2.1.3. Ventilation grille.....	16
2.1.4. Wrist-rest and side trims.....	17
2.2. Description of the rear panel and connections.....	18
2.2.1. Power supply.....	19
2.2.2. System common I/O's.....	19
2.2.2.1. GPIO.....	20
2.2.2.1.1. Opto-coupled GPI.....	20
2.2.2.1.2. Opto-coupled GPO.....	21
2.2.2.1.3. Physical contact GPO.....	21
2.2.2.2. Ethernet ports.....	22
2.2.2.3. Synchronism.....	23
2.2.2.4. Control and studio monitors.....	23
2.2.2.5. Control and studio headphones.....	24
2.2.2.6. Orders microphone.....	24
2.2.2.7. Optional MADI communications module.....	25
2.2.3. Audio inputs/outputs modules.....	25
2.2.3.1. FR02 Digital inputs/outputs module.....	26
2.2.3.2. FR03 Mic/Line inputs module.....	27
2.2.3.3. FR04 Analogue line inputs module.....	28
2.2.3.4. FR05 Analogue line outputs module.....	29
2.2.3.5. FR22 USB inputs/outputs module.....	30
2.2.3.6. FR33 Telephone hybrid module.....	31
2.2.4. Wiring.....	32
3. DESCRIPTION OF THE INTERNAL MENU.....	33
3.1. "CLOCK" menu.....	33
3.2. "LOGIN/LOGOUT" menu.....	35
3.3. "MEMORY" menu.....	37
3.4. "MAIN MENU".....	37
3.4.1. "INFO" menu.....	38
3.4.2. "SETUP" menu.....	39
3.4.3. "SELECT" menu.....	40
3.4.3.1. "INPUT" menu.....	40
3.4.3.1.1. Dynamics menu: Compressor/Limiter and Noise Gate... ..	42
3.4.3.1.2. Equalizer and filter menu .....	44
3.4.3.1.3. Expanded information menu.....	45

3.4.3.1.3.1. "FADER" menu.....	46
3.4.3.1.3.2. "ROUTE" menu.....	46
3.4.3.2. "OUTPUT" menu.....	47
4. CONFIGURATION SOFTWARE.....	49
4.1. "Administration" menu.....	52
4.1.1. "Configurations" submenu.....	52
4.1.2. "User Configuration" submenu.....	55
4.1.3. "About Forum Setup" submenu.....	57
4.2. "Hardware Configuration" menu.....	57
4.2.1. "Board Configuration" submenu.....	58
4.2.1.1. "Module Configuration" section.....	59
4.2.1.2. "Internal Module Configuration" section.....	60
4.2.2. "Mixer Bus Configuration" submenu.....	62
4.2.3. "I/O Configuration" submenu.....	64
4.2.3.1. Advanced configuration of input channels menu.....	65
4.2.3.2. Advanced configuration of output channels menu.....	67
4.2.4. "Monitoring Configuration" submenu.....	68
4.2.4.1. "Studio Room Section".....	69
4.2.4.2. "Control Room Section".....	69
4.2.5. "NTP Client Configuration" submenu.....	70
4.3. "Programmable Configuration" menu.....	71
4.3.1. "Routing Configuration" submenu.....	71
4.3.2. "Programmable Keys" submenu.....	73
4.3.2.1. Basic configuration of programmable keys.....	73
4.3.2.2. Configuration of "General" programmable keys.....	74
4.3.2.3. Configuration of "Salvo" programmable keys.....	75
4.3.2.4. Configuration of "Codec" programmable keys.....	77
4.3.2.5. Configuration of "Multiplex" programmable keys.....	81
4.3.2.6. Configuration of "Cue Reset" programmable key.....	82
4.3.2.7. Configuration of "Orders" programmable key.....	82
4.3.3. "Mic Group Configuration" submenu.....	83
4.3.4. "Preset Configuration" submenu.....	84
4.3.4.1. Advanced configuration of Compressor/Limiter.....	86
4.3.4.2. Advanced configuration of Noise Gate.....	88
4.3.4.3. Advanced configuration of Equalizer.....	89
4.3.4.4. Advanced configuration of Low Pass Filter.....	89
4.3.4.5. Advanced configuration of High Pass Filter.....	90
4.3.5. "SnapShot Configuration" submenu.....	91
4.3.5.1. Advanced configuration of inputs.....	93
4.3.5.2. Advanced configuration of outputs.....	94
4.3.5.3. Advanced configuration of internal summing buses.....	95
4.4. "Firmware Upgrade" menu.....	96
4.4.1. "Tree View" submenu.....	96
4.4.2. "Upgrade View" submenu.....	99
4.4.3. "Log View" submenu.....	100
5. A.E.Q. GUARANTEE.....	101

## 1. INTRODUCTION.

### 1.1. General overview.

**AEQ FORUM** and **AEQ GRAND FORUM** are digital audio mixers for Broadcast applications, specifically designed for ON AIR applications and highly adaptable to different operational situations. They incorporate all the basic features needed in such environments: automatic monitors muting, cough muting, fader-start, signalling control, control signals for external equipment automation, management of external communications, intercoms, etc.

The modular design and reduced size makes those mixers perfectly adaptable to many different scenarios: self-control, control-studio, audio control in television, sound production, mixed configurations, integration in large systems, etc.

One of the main qualities of both them is the extensive internal routing capacity which provides: up to 64 inputs/outputs for analogue, digital or microphone audio signals, and another 64 input/output multichannel audio over a MADI link (in order to activate this function you must purchase a user license).



NOTE: The exterior of the equipment and some screens or displays may vary depending on version.

The power of control and simplicity are combined in **AEQ FORUM** to cover both basic and advanced operating needs, starting with a 4 faders control surface that can easily be expanded to 8 or 12 faders; in the case of **AEQ GRAND FORUM**, it can be expanded up to 16 or 20 faders.

All basic functions of activation, level adjustment and routing have their specific controls on each channel of the FORUM surface, while less common adjustments are included in a set of contextual controls common to all channels and accessible with just one or two keystrokes: simplicity and clarity of use for dynamic control without handling error.

The flexibility offered through the configuration of the system enables the free assignment of any audio input of the system to any control channel, and changing the distribution of signals from the surface itself or the associated configuration software.

The digital mixer includes memory banks that store the settings for each signal: control surface signal distribution, routing to the output buses, management of parameters and activation of the different available audio processes. This allows the console to adapt easily to different programs with different technical requirements.

Its two Ethernet ports enable the local or remote interconnectivity, facilitating set-up and maintenance, monitoring and control.

Forum has also been designed to ensure interoperability with communications equipment and future developments by AEQ or other manufacturers.

## 1.2. Functional specifications.

- Self-contained Design.
- Configurable size of 4, 8 or 12 faders (up to 16 or 20 faders for AEQ GRAND FORUM). Conductive plastic faders 100mm.
- Internal sampling rate 48 kHz to 24 bits. Variable through external clock referente.
- Modular design that allows you to adjust the number of inputs and outputs of the equipment to the requirements of each facility. Front removable modules for easy maintenance.
  - Up to 14 modules of multiple inputs and outputs, out of which 4 can be double micro- line and 2 digital hybrid.
  - Electronically balanced microphone inputs with phantom power.
  - Electronically balanced analogue line Inputs and outputs. Adjustable gain  $\pm 12$ dB. Balance/panoramic control selectable for all channels. Selective phase inversion. Adjustable gain for up to 128 signals, including hidden signals.
  - Transformer balanced digital inputs and outputs with adjustable gain  $\pm 12$  dB. Balance/panoramic control selectable for all channels. Selective phase inversion. Adjustable gain for up to 128 signals, including hidden signals.
  - Sample rate converter (SRC) for all digital inputs. Supports AES/EBU and S-PDIF digital signal formats.
  - Additional input, integrated talk-back and auto-control micro-line.
  - Integrated monitor and headphone outputs for control and studio. Cough mute, ON-AIR signalling for studio and control, fader-start, remote PFL, talk-back, automatic monitors muting. Monitoring can be configured for any of the system signals.
  - CUE output and integrated CUE speaker.
  - Headphone outputs integrated into the chassis.
  - PFL Monitor integrated in chassis.
  - Optional 64 channels digital MADl optical fiber connection (available by means of user license).
  - Test tone (1KHz) generator.
  - 8 Opto-coupled GPI's and GPO's and 4 relay contact GPO's.
- 4 direct routing buttons on each channel.
- Internal Routing 64x64 mono, with additional capability for routing signals from the optional MADl interface (available by means of user license).
- All signals assignable to any control channel.
- Configuration of up to 8 MPX internal buses.
- 2 precision stereo VU meters.
- Externally synchronized clock, timer and stopwatch.
- Control of external equipment (AEQ hybrids and audio codecs) integrated in the programmable key section.
- Communication control via Ethernet 10/100 connection through TCP / IP protocol. For more information see chapter "4. CONFIGURATION SOFTWARE" of this manual.
- Memory banks for mixer snapshots or settings of all the available signals: up to 7 available memories.
- Processing of audio signals including system defaults to the basic configuration.
  - Audio processing capacity for up to 20 stereo signals (up to 12 in Fader and 8 hidden).
  - All audio processes are predefined but always allow manual adjustment in real time and associated non-volatile memory storage system.
  - Audio effects are available: parametric equalizer, high and low pass filters, compressor/limiter and noise gate.
- Noiseless natural convection. AEQ FORUM is particularly suitable for self-operation formats.
- Optional redundant power supply.

## 2. PHYSICAL DESCRIPTION OF THE UNIT.

AEQ FORUM is a self-contained, compact digital mixing console, which means that its two functional blocks are housed in the same physical chassis. On one hand the control surface, where the controls and status indicators are located and on the other, the "audio engine" which contains all electronics for audio inputs and outputs as well as routing blocks, summing and processing.

Both functional blocks will be separately described below.

### 2.1. Description of the control surface.

Control surface is the operators work area of the AEQ FORUM. All the operational organization, management and implementation of the audio program is accomplished from this area. The control surface incorporates all the keys, screens, faders, encoders and VU meters required to easily operate the equipment.

There are two different areas on the AEQ FORUM control surface: the area that corresponds to the audio channels controlled through faders (each module includes 4 faders) and the "CONTROL AND MONITORING MODULE" which is normally located to the right.

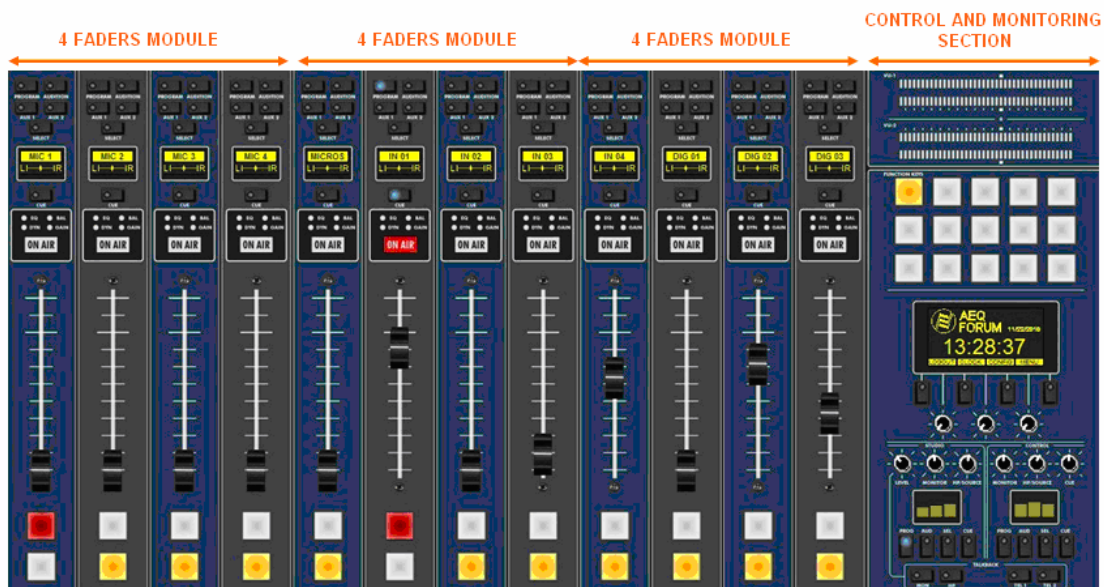

#### 2.1.1. Channels.

The **AEQ FORUM** control surface is built on independent modules of 4 faders called "FRCH". The control surface capacity can be expanded from a basic configuration of 4 channel faders to 8 and up to 12 **channel faders**. For **AEQ GRAND FORUM**, it can be expanded up to 16 or 20 **faders**.

The assignment of signals to channel faders on the AEQ FORUM is completely user definable. It is possible to assign any signal to any channel fader at any time. This allows for the re-distribution channels to adapt to different programs or operators.

In addition, different channel assignment of signals can be stored in memory to be used by different users or applications.

In addition to the signals on channel faders present on the control surface that can be mixed, processed and sent to any output channel, the AEQ FORUM is capable of routing and adjusting the levels for other hidden signals up to 128x128 audio signals.



Located in the upper part of the channel are 4 routing keys (“PROGRAM”, “AUDITION”, “AUX1” and “AUX 2”) and a “SELECT” button to assign the channel to advanced settings common control (gain, dynamics, EQ and balance).

Beneath this section, an OLED display shows channel name and status for balance or pan. Immediately under the display is located the Pre-listen button “CUE”, 4 status indicators LEDs that alerts with regards to the activation of equalization (“EQ”), dynamics (“DYN”), balance (“BAL”) and gain (“GAIN”). Also in this section, a luminous label indicating that the channel is activated and is sending signal to the output buses (“ON AIR”).

By pressing the “SELECT” button the advanced configuration functions are enabled. These configurations are accomplished within the integrated multifunction display in the control and monitoring section at the far right of the control surface. Its operation is based on rotary encoder and graphical menus and short-cut function keys, depending on the information shown on screen.



Among the general functions are the instant activation and adjustment of audio effects (EQ, filters, limiters, etc.), configurations and memories management, disconnection of applied effects, phase change, inserting of a test signal, as well as clock, timer and stopwatch for timing control, etc. For more information see chapter “**3. DESCRIPTION OF THE INTERNAL MENU**” of this manual.

The Channel module is completed with plastic conductive sliding faders and the Channel ON and OFF buttons.



### 2.1.1.1. Routing keys.

There are four keys on the top of the channel that routes the channel signal to the corresponding output bus. Activation is indicated through the integrated LEDs in each of these keys, and indicates the creation of a cross point between the input signal on the channel and the output channel corresponding to the key.



From left to right and top to bottom, the four keys of direct routing are “**PROGRAM**” (sending to master 1), “**AUDITION**” (sending to master 2), “**AUX1**” (sending to auxiliar 1) y “**AUX2**” (sending to auxiliar 2). The allocation of physical outputs associated with these signals and the physical circuits of the inputs/outputs modules on the back of AEQ FORUM is accomplished from the configuration software. For more information, please refer to chapter “**4. CONFIGURATION SOFTWARE**” of this manual.

### 2.1.1.2. SELECT.

The control surface of AEQ FORUM offers the usual controls for a mixing console on each channel, but AEQ FORUM also offers a wide range of possibilities for routing and processing, beyond the physical options included in each channel. These possibilities have been distributed in a logical manner within internal menus accessible from the main screen of the Control and Monitoring section.

The operation is intuitive, always beginning with pressing the “**SELECT**” button on the channel that you want to process and moving to the main screen of the Control and Monitoring section of the console to accomplish the activations or adjustments. For further details please refer to chapter 3.4.3.1 of this manual.

### 2.1.1.3. Channel display.

Each of the 12, 8 or 4 channels (depending on the AEQ FORUM configuration ordered) integrates a two-colour OLED display (yellow/black) showing:

- Name of the associated audio signal (maximum 6 characters, editable via the configuration software). For more information see chapter “4. CONFIGURATION SOFTWARE” of this manual.
- Status of balance between left (L) and right signal (R) in stereo signals (or panoramic for monophonic signals).





### 2.1.1.4. CUE.

This button allows you to activate a pre-fader listening to the audio channel for monitoring and control. When activated the integrated LED is lit. It is possible to send the audio signals of several channels to the CUE bus, acting as a summing bus.

There is the option of setting one of the programmable keys on the Control and Monitoring section (C&M) as a general “CUE RESET” that disconnects all active signals from the CUE bus.

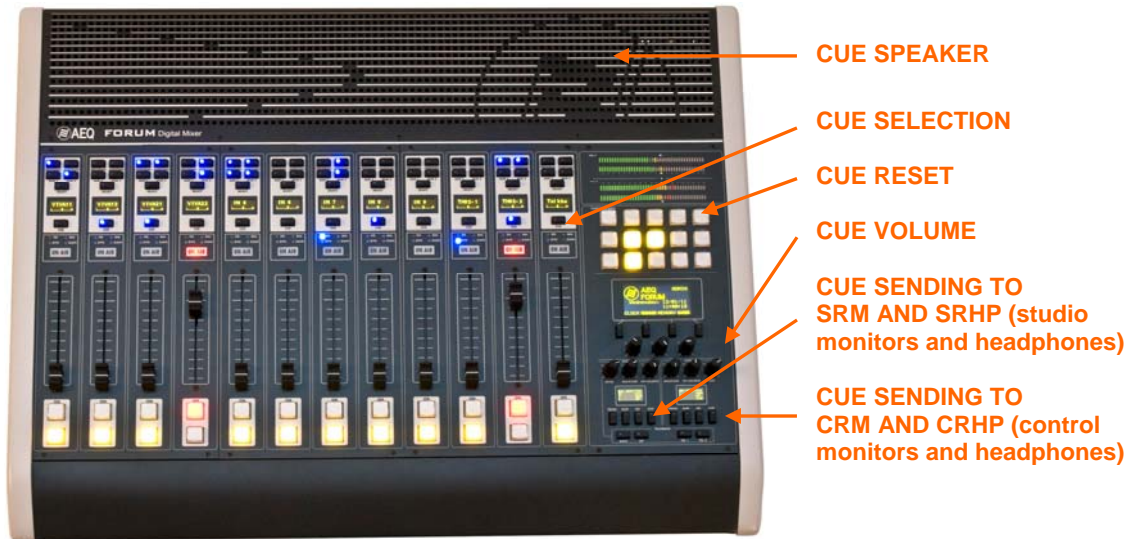

CUE signal associated controls

The CUE speaker is built-in in the upper right of the control surface, beneath the ventilation grille, and the volume control is through an encoder in the Control and Monitoring section of the control surface.

### 2.1.1.5. Indicators of active processes.

Under the “CUE” button there are four blue LEDs with corresponding labels, from left to right and top to bottom, “EQ” (equalizer), “BAL” (balance), “DYN” (dynamic processor) and “GAIN”. The lit status indicates the activation of any of the four processes previously mentioned in a certain fader channel.



These four processes (EQ, dynamics, balance and gain) are controlled from the internal menu associated with the “SELECT” button on the main screen of the Control and Monitoring section.

### 2.1.1.6. ON AIR LED.

Under the lights of active processes is located the “ON AIR” warning light. This light is ON when the audio signal present at the input of the channel is sent to any of the outputs previously described (see section “3.4.3.1.3.2 ROUTE menu” of this manual).

For this, two conditions must be met simultaneously:

- Channel fader is located in any position except at minimum of travel of the fader.
- Channel ON key is activated.



### 2.1.1.7. Fader.

100mm conductive plastic fader. The fader travel is printed with 11 bands, the maximum output level +22dB corresponding to the last, and the third band from above to +0dB or nominal operating level. Both of these marks are differentiated in size from the rest.



The response mode of the fader is logarithmic, producing great attenuation of the level at the bottom of the fader travel and less adjustment at the top.

The bottom position of the fader travel, triggers gain  $-\infty$ dB or absence of signal, which is also reflected in the channel “ON AIR” indicator (it turns off).

### 2.1.1.8. Channel activation keys.

The channel activation keys, “CHANNEL ON/OFF”, enable or disable the sending of the audio signal present at the channel input to the outputs previously defined. If the sliding fader is located in any position of the fader travel other than the minimum, the channel on or off activation will be reflected through the “ON AIR” indicator previously described.

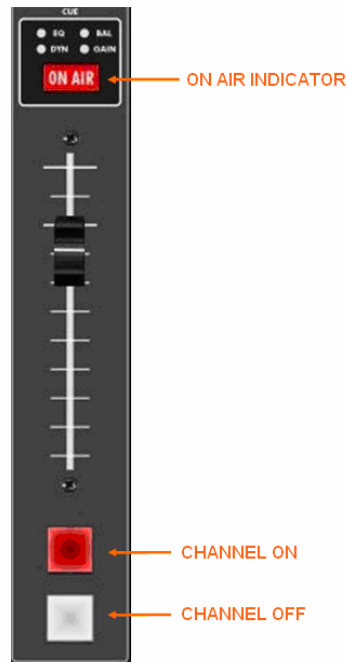

The upper key is associated to **ON** function and has a red light built in and the lower one is associated to **OFF** function and has a yellow light. The operation is exclusive, both keys can not be turned on simultaneously.

These keys can be activated remotely by GPI. To configure remote activation, see chapter 4.2.3.1 of this manual.

### 2.1.2. Control and monitoring section.

The control and monitoring section (C&M) of the control surface is usually located to the right. This section enables the overall management of the signals on the system, including routing and control processes, as well as monitoring of the signals used in developing the final program, by means of the VU-Meters, and CUE control.

This control and monitoring section is divided into four main areas:

- **Control VU meters:** allows you to monitor visually the level of the audio signals from the master output and the CUE bus (or the control monitoring bus, when there are no channels sent to CUE).
- **Programmable keys:** dedicated buttons with special functions defined through the configuration software.
- **Main screen:** it displays the internal menus. This section also incorporates contextual keys and encoders.
- **Studio, Control and Talk-back monitoring:** where you can manage the audio signals sent to the headphones and speakers, for the control room and the studio room, as well as the talk-back functions for the intercom for both areas.

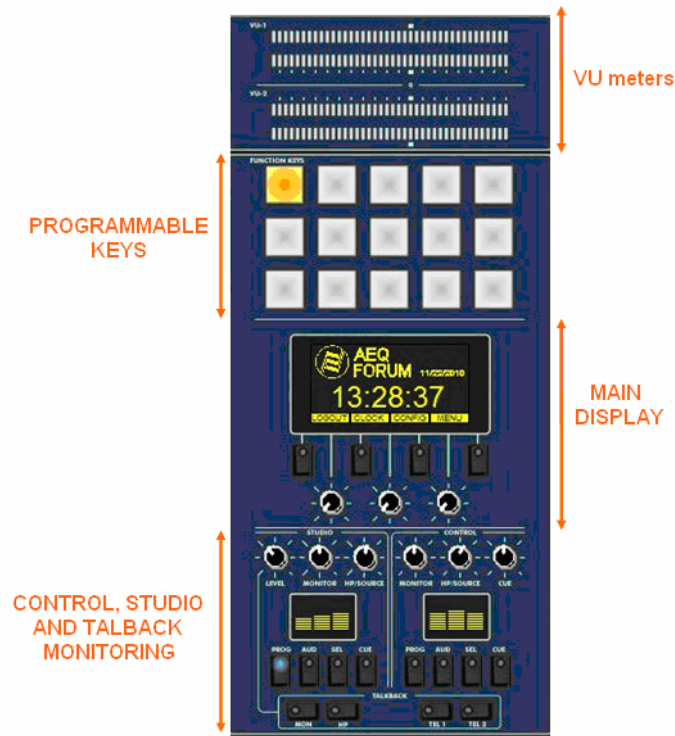

### 2.1.2.1. Control VU meters.

There are two 40 segment LED stereo VU meters. The upper one shows the **Program** output and the lower one the **CUE** bus (or the **control monitoring** bus, when there are no channels sent to CUE).

From left to right, the first 25 LEDs are green, followed by an area of 5 yellow LEDs to finish with an area of 10 red LEDs. 0dB point or nominal value corresponds to the the yellow LED adjacent to the first red LED.

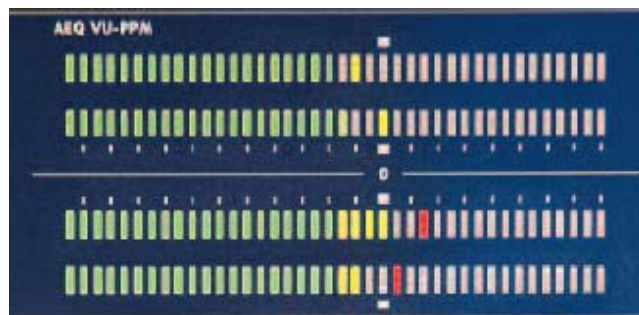

Both VU meters are set to function as IEC268-10: 5ms/-2dB (vu-meter only) and the peak-meter IEC268-17: 300 ms (vu-meter & Flying PPM) superimposed.

### 2.1.2.2. Programmable keys.

The Control and Monitoring area of the AEQ FORUM includes 15 programmable keys in three rows of 5 columns.

These programmable keys can be configured through software to perform specific functions such as salvos, GPI, GPO, external codecs control. For more information see section 4.2.1.2 of this manual.

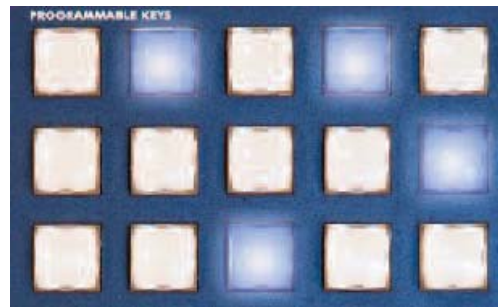

The operation of the programmable keys allows two possibilities:

- **NORMAL:** the pressing of the key triggers the the execution of the programmed action. Pressing it again will produce the end of the previously launched action, or in the case of SALVOS, even the opposite action or disconnection of the SALVO.
- **PTT (PUSH-TO-TALK):** the pressing of the key will trigger the execution of the programmed action but only remains active as long as you keep the button pressed.

All keys can be easily labelled, removing the translucent plastic cover and inserting a text label. AEQ supplies with the equipment a template that allows you to create these labels on clear acetate or plain paper.

### 2.1.2.3. Main screen.

The main screen is a two coloured OLED (yellow/black) 128x64 pixel resolution display, that shows the entire internal advanced menu of the AEQ FORUM. For more information see section “3. DESCRIPTION OF THE INTERNAL MENU” of this manual.

To simplify operations in the internal menu shown on this screen there are four short-cut keys and three associated rotary encoders. Depending on the information shown on the last line of the menu screen visible on the main display, these short-cut keys will have a function or another.

At most, the last line will have four menu options visible from left to right, and they are directly associated with short-cut keys from left to right.

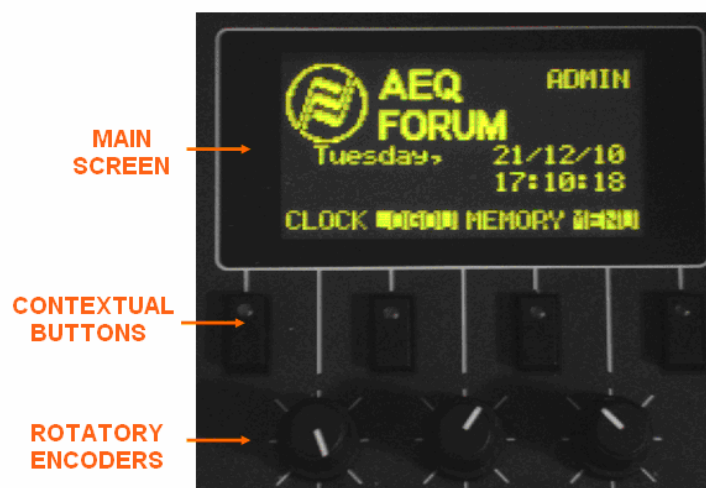

The three rotary encoders are related to the remaining lines of the menu. Each screen is described in chapter 3 of this manual but the thumb-rule for the association of the rotary encoder to the visible functions is: option visible to the left or in the upper part of the menu is controlled from the encoder located to the left. In many cases the encoders are represented and labelled on the screen for easy operation.

#### 2.1.2.4. Control room monitoring section.

Located in the lower right corner of the AEQ FORUM control surface are a two-coloured display, three rotary encoders and four keys.

- In the two-coloured OLED display are shown the output levels for the control monitoring signals and the selected sources in each case, for control headset, control speakers and CUE.



- The three rotary encoders, from left to right, are:
  - **“MONITOR”**: it controls the audio level for the physical output for the control room monitors. To decrease the level turn the encoder to the left. To increase the level turn the encoder to the right.
  - **“HP/SOURCE”**: it controls the audio level for the physical output for the control headphones. To decrease the level turn the encoder to the left. To increase the level turn the encoder to the right. This encoder can also be used to select the signal to monitor associated with the key **“SEL”**: press to access a list of signals, and turn the encoder to move up or down in the list of signals; pushing the encoder a second time confirms the selection of the highlighted signal.



- **“CUE”**: it controls the audio level of the CUE speaker of the AEQ FORUM. To decrease the level turn the encoder to the left. To increase the level turn the encoder to the right.
- The four keys under the display allows to select the signal to monitor on control speakers and headset, from left to right:
  - **“PROG”**: allows you to monitor the audio signal **Program**.
  - **“AUD”**: allows you to monitor the audio signal **Audition**.
  - **“SEL”**: allows you to monitor any signal of the console previously selected by means of **“HP/SOURCE”** encoder.
  - **“CUE”**: allows you to monitor the audio signal present on the CUE bus.

These four keys can have two working modes that are selected from the Configuration Software (see section 4.2.4 of this manual):



- **“Mixer”**: each key pressed adds the signal to be monitored to the summing bus.
- **“Exclusive”**: each key pressed connects the signal to the summing bus and disconnects any signal previously selected.

In case there are no channels sent to CUE, the signal or signals selected in this section will be shown in the lower control VU meter (see section 2.1.2.1 of this manual).

### 2.1.2.5. Studio room monitoring section.

Located in the lower left corner of the AEQ FORUM control surface are a two-coloured display, three rotary encoders and four keys.

- In the two-coloured OLED display are shown the output levels for the studio monitoring signals and the selected sources in each case, for studio headset, studio speakers and CUE.



- The three rotary encoders, from left to right, are:
  - **“LEVEL”** (Talkback Level): it controls the gain of the TALKBACK microphone. To decrease the level turn the encoder to the left. To increase the level turn the encoder to the right.
  - **“MONITOR”**: it controls the audio level for the physical output for the studio room monitors. To decrease the level turn the encoder to the left. To increase the level, turn the encoder to the right.
  - **“HP/SOURCE”**: it controls the audio level for the physical output for the studio headphones. To decrease the level turn the encoder to the left. To increase the level, turn the encoder to the right. This encoder can also be used to select the signal to monitor associated with the key “SEL”: press to access a list of signals, and turn the encoder to move up or down in the list of signals; pushing the encoder a second time confirms the selection of the highlighted signal.



- The four keys under the display allows to select the signal to monitor on studio speakers and headset, from left to right:
  - **“PROG”**: allows you to monitor the audio signal **Program**.
  - **“AUD”**: allows you to monitor the audio signal **Audition**.
  - **“SEL”**: allows you to monitor any signal of the console previously selected by means of “HP/SOURCE“ encoder.
  - **“CUE”**: allows you to monitor the audio signal present on the CUE bus.



These four keys can have two working modes that are selected from the Configuration Software (see section 4.2.4 of this manual):

- **“Mixer”**: each key pressed adds the signal to be monitored to the summing bus.
- **“Exclusive”**: each key pressed connects the signal to the summing bus and disconnects any signal previously selected.

### 2.1.2.6. Talkback.

Talk-back section allows the console operator to communicate directly with the studio and remote guests (lines).

The default intercom channels for the AEQ FORUM are between the control room and the studio, independent between monitors and headphones. You can set additional channels of intercom to facilitate communications. For example, talk-back can be established between studio or control to the different audio returns to hybrids or audio-codecs. The talk-back microphone can also be used as an auto-control microphone if so defined.



The talk-back section of the control surface consists of 4 key buttons immediately beneath the Studio and Control sections and the encoder “LEVEL” (Talkback Level) of the Studio monitoring section.

From left to right are:

- **“MON”**: talk-back to studio monitors.
- **“HP”**: talk-back to studio headphones. The default configuration of the AEQ FORUM does not differentiate between primary and secondary headphones. It is possible to establish a secondary group of headphone creating a salvo to be triggered from the programmable keys.
- **“TEL 1”**: talk-back to the telephone hybrid line 1 (AEQ FORUM allows a maximum of 2 single line digital telephone hybrid modules **FR33**, but has 8 MPX internal buses hidden that can be used with dedicated lines, external audio codecs or telephone hybrids. The talk-back to dedicated lines, external audio-codecs or telephone hybrids can be established through the use of the programmable keys).
- **“TEL 2”**: talk-back to the telephone hybrid line 2.

### 2.1.3. Ventilation grille.

The base of the equipment and the top of the control surface have micro-perforations to allow the passing of a stream of air naturally created by convection due to the heat dissipated by the equipment electronics. The distance from the equipment base to the table top has to be respected by at least the height of the equipment rubber feet and it is paramount not to obstruct the ventilation grille on the top of the control surface.



The AEQ FORUM design does not include a fan or mechanical heat sink thus ensuring silent operation, perfect for self-control facilities or applications that require absolute silence.

The right side of the vent area integrates the CUE speaker.

#### **2.1.4. Wrist-rest and side trims.**

The AEQ FORUM has a frame around the sides and bottom of the control surface, forming part of the chassis that houses all the electronics. This framework is transformed into a wrist-rest at the bottom.

The standard AEQ FORUM is delivered with wooden side trims and a wrist-rest for desktop installation of the mixer. As an option, the AEQ FORUM can be provided without the side trims and with L-shaped metal profiles to allow the countersunk installation of the mixing console.

## 2.2. Description of the rear panel and connections.

The ease of installation and set-up has been a priority in the design of AEQ FORUM. The equipment is self-contained and can be installed either desktop or countersunk.

To connect cough cut, remote control of external devices, ON AIR lights, etc... AEQ FORUM has 8 general purpose inputs (GPI), 8 general purpose outputs (GPO) and another 4 relay outputs. The AEQ FORUM has a set of predefined control and studio monitors and headphones including auto-control and orders microphone. Remote configuration and control is via two Ethernet connections.

AEQ FORUM has an optional bi-directional MADi interface (available by means of user license) that can carry up to 64 digital inputs and outputs as well as 14 slots for analogue or digital I/O and digital telephone hybrid modules.

For ease of wiring and avoid errors in the installation process, audio and data cables and DB connectors required to connect the console can be optionally supplied. In any event, it is necessary to use shielded and balanced audio cables and that the connection to the DB connectors are made by technically qualified personnel and properly verified before connecting the equipment. Further, optional power supplies and wiring for control and studio signalling and GPIO can be supplied.

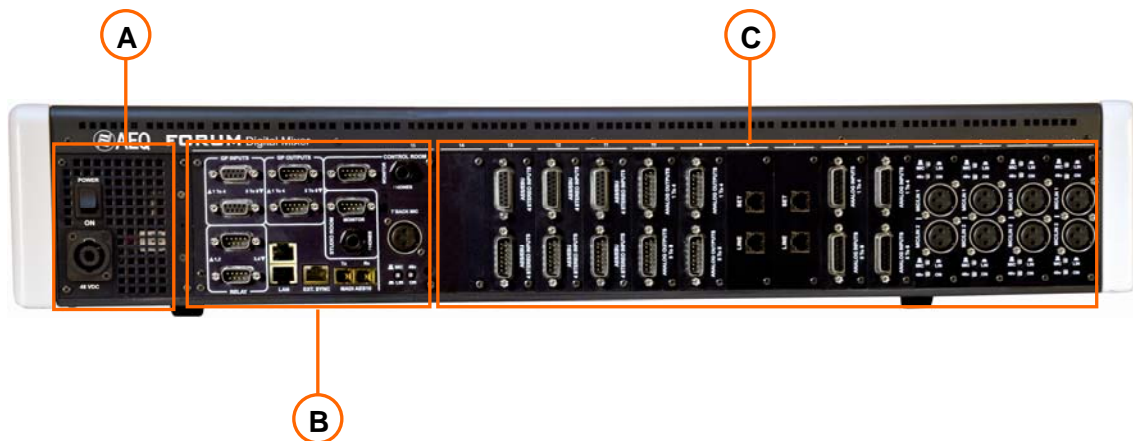

The AEQ FORUM's 14 available slots for inputs/outputs modules are labelled from 1 to 14 starting from the right of the console, rear view, reserving the number 15 for the system common I/O module, and the name AES10 MADi for the MADi interface option (available by means of user license). These references are the same as those used in the configuration software. For more information see chapter "3. DESCRIPTION OF THE INTERNAL MENU" of this manual.

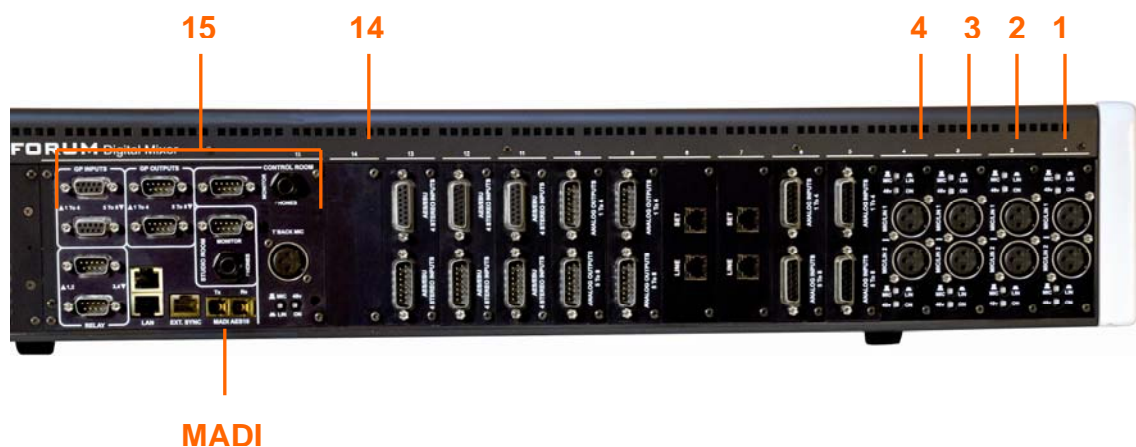

### 2.2.1. Power supply. A

On the left side of rear FORUM is placed the power supply module which incorporates the DC/DC converters that provides the internal circuitry power of the console. Externally you can see the 48V DC Speak-On connector to which the external 48V DC power supply is connected. The power supply provided is switching and supports between 100 and 240VAC, delivering 160W-3, 34A @ 48 V DC.



AEQ FORUM external power supply

On request, a redundant 2RU rack-mounted power supply can be delivered. In the case of installing this redundant power supply, it has to be adequately located so as to avoid the hum of the fans installed in the power supply being picked up by any microphone.



Redundant power supply for AEQ FORUM

### 2.2.2. System common I/O's. B

This section of the AEQ FORUM rear panel includes inputs and outputs required to integrate the equipment in a broadcast facility such as audio outputs to several external speakers and headphones, general purpose inputs and outputs allowing remote options, talk-back microphone...

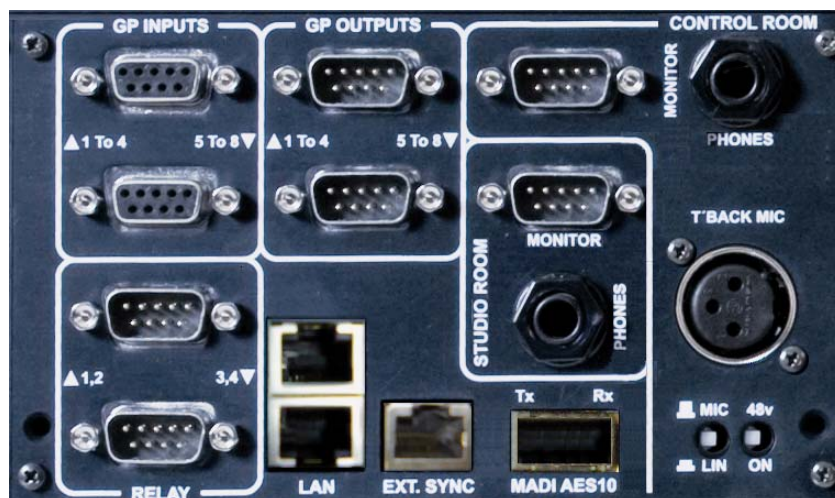

### 2.2.2.1. GPIO.

AEQ FORUM incorporates several electronic general purpose interfaces (GPIO), either of the opto-coupled or physical contact type and always available on the rear panel of the unit

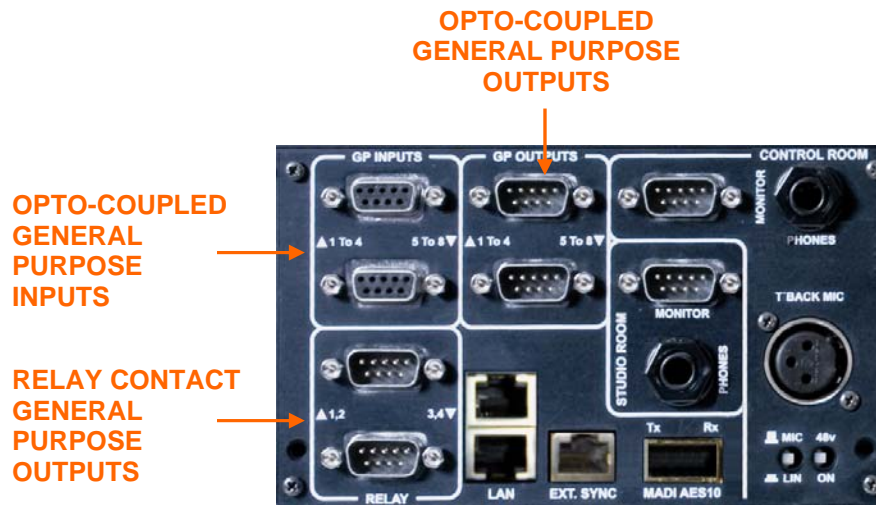

#### 2.2.2.1.1. Opto-coupled GPI.

The AEQ FORUM includes 8 electronic interface of opto-coupled type GPIs through the two female DB9 connectors in the “GP INPUTS” section. One of them houses the GPIs numbered from 1 to 4 and the other one from 5 to 8.

Specifications:

- Opto-coupler protected inputs (TLP127).
- Maximum Input Current: 50mA.
- Applicable voltage: from 5V to 24V.

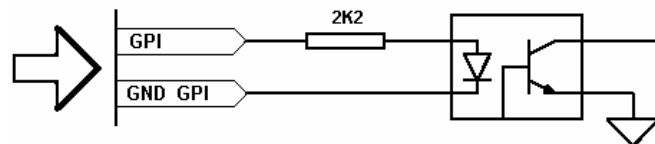

Electronic associated with opto-coupled GPI

In order to simplify the installation, AEQ offers a prefabricated wiring kit specifically for GPI inputs: CAB FR GPI, male DB9 connector soldered to 4 meters of cable open-end termination for GPI. More information in section 2.2.4 of this manual.

GPI inputs (2 x SUB-D female 9 pin):

Pin	GP INPUTS 1 To 4 connector	GP INPUTS 5 To 8 connector
1	GPIN1	GPIN5
2	GPIN2	GPIN6
3	GPIN3	GPIN7
4	GPIN4	GPIN8
5	Not connected	Not connected
6	GND_GPIN1	GND_GPIN5
7	GND_GPIN2	GND_GPIN6
8	GND_GPIN3	GND_GPIN7
9	GND_GPIN4	GND_GPIN8

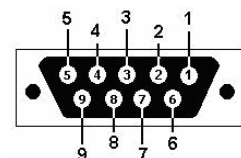

On request, this wiring kit can be supplied with connectors explicitly specified by the customer. For more information please refer to AEQ sales department or authorised distributors.

### 2.2.2.1.2. Opto-coupled GPO.

The AEQ FORUM includes 8 electronic interface of opto-coupled type GPOs through the two male DB9 connectors in the “**GP OUTPUTS**” section. One of them houses the GPOs numbered from 1 to 4 and the other one from 5 to 8.

Specifications:

- Opto-coupler protected outputs (TLP127).
- Maximum current: 80mA.
- Recommended Maximum voltage: 200V.
- Maximum power: 100mW at 40 ° C.
- Requires external power.

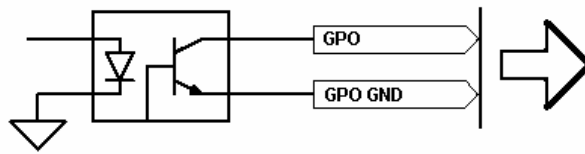

Electronic associated with opto-coupled GPO

In order to simplify the installation phase, AEQ offers a prefabricated wiring kit specifically for GPO outputs: CAB FR GPO, female DB9 connector soldered to 4 meters of cable open-end termination for GPO. More information in section 2.2.4 of this manual.

GPO outputs (2 x SUB-D male 9 pin):

Pin	GP OUTPUTS 1 To 4 connector	GP OUTPUTS 5 To 8 connector
1	GPOUT1	GPOUT5
2	GPOUT2	GPOUT6
3	GPOUT3	GPOUT7
4	GPOUT4	GPOUT8
5	Not connected	Not connected
6	GND_GPOUT1	GND_GPOUT5
7	GND_GPOUT2	GND_GPOUT6
8	GND_GPOUT3	GND_GPOUT7
9	GND_GPOUT4	GND_GPOUT8

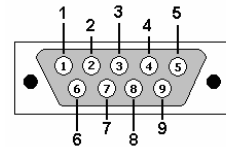

On request, this wiring kit can be supplied with connectors explicitly specified by the customer. For more information please refer to AEQ sales department or authorised distributors.

### 2.2.2.1.3. Physical contact GPO.

The AEQ FORUM includes 4 physical contact type GPOs through the two male DB9 connectors in the “**RELAY**” section. One of them houses the GPOs numbered from 1 to 2 and the other one from 3 to 4.

Specifications:

- Contact closure relay.
- Maximum current: 1 A @ 30 v. DC, 0.3 A @ 125 V AC.
- Maximum voltage: 60 V DC or 125 v. AC.
- Maximum power: 30 VA.



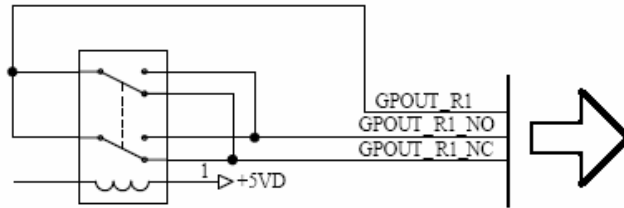

Electronic associated with physical contact GPO

In order to simplify the installation phase, AEQ offers a prefabricated wiring kit specifically for GPO outputs: CAB FR GPR, female DB9 connector soldered to 4 meters of cable open-end termination for GPO. More information in section 2.2.4 of this manual.

GPO Relay outputs (2 x SUB-D male 9 pin):

Pin	RELAY 1,2 connector	RELAY 3,4 connector
1	GPOUT_RL1	GPOUT_RL3
2	GPOUT_RL1_NO	GPOUT_RL3_NO
3	Not connected	Not connected
4	Not connected	Not connected
5	GPOUT_RL2_NC	GPOUT_RL4_NC
6	Not connected	Not connected
7	GPOUT_RL1_NC	GPOUT_RL3_NC
8	GPOUT_RL2	GPOUT_RL4
9	GPOUT_RL2_NO	GPOUT_RL4_NO

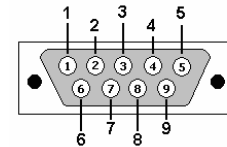

On request, this wiring kit can be supplied with connectors explicitly specified by the customer. For more information please refer to AEQ sales department or authorised distributors.

### 2.2.2.2. Ethernet ports.

In the area of common inputs and outputs of the AEQ FORUM are two 10/100BaseT RJ45 Ethernet connectors to interconnect the mixing console with external devices using IP communication protocols.



LAN (lower) and ETHERNET (top) connectors

Any of the two connectors can be used to interconnect the AEQ FORUM with an external computer that is running the configuration software. By default, the IP address associated to "LAN" port is 172.31.34.1 and the one associated to "ETHERNET" port is 172.26.34.1: both addresses can be modified if you have the right user level (see section 3.4). For further information see chapter "4. CONFIGURATION SOFTWARE" of this manual.

**IMPORTANT NOTE: the IP addresses of both Ethernet ports must not be configured into the same network.** For instance, if "LAN" port is configured with 172.31.34.1 IP address and 255.255.0.0 mask, the IP address of the "ETHERNET" port should be different from 172.31.x.x (where x is any number between 0 and 255).



The RJ45 pin-out is as follows:

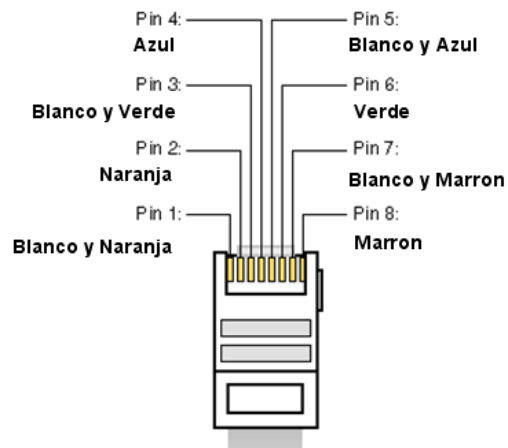

### 2.2.2.3. Synchronism.

AEQ FORUM has an external sync input for AES 11 and TTL formats. The input connector is an RJ45 on the rear panel of the unit identified as “**EXT. SYNC**”.

Pin	EXT.SYNC connector
1	TTL_SYNC_IN
2	TTL_SYNC_IN_GND
3	TTL_SYNC_OUT
4	GND
5	AES_SYNC_OUT+
6	AES_SYNC_OUT-
7	AES_SYNC_IN+
8	AES_SYNC_IN-
Case	Earth

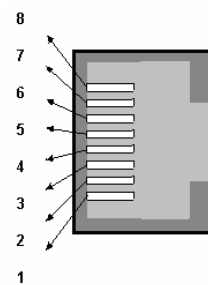

### 2.2.2.4. Control and studio monitors.

AEQ FORUM includes monitor outputs for Studio and Control monitors. These outputs are provided on a male DB9 connector.

The speaker output for the control is called “**MONITOR**” and within the “**CONTROL ROOM**” section on the rear panel of the equipment.

The speaker output for the studio is called “**MONITOR**” and within the “**STUDIO ROOM**” section on rear panel of the equipment.

In order to simplify the installation phase, AEQ offers a prefabricated wiring kit specifically for monitoring outputs: CAB FR MON, female DB9 connector soldered to 4 metres of cable open-end termination for two monitor outputs. More information in section 2.2.4 of this manual.

Control / Studio Monitoring outputs (SUB-D male 9 pin):

Pin	MONITOR STUDIO connector	MONITOR CONTROL connector
1	GND	GND
2	OUT L-	OUT L-
3	Not connected	Not connected
4	GND	GND
5	OUT R-	OUT R-
6	OUT L+	OUT L+
7	Not connected	Not connected
8	Not connected	Not connected
9	OUT R+	OUT R+

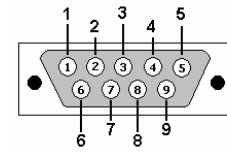

On request, this wiring kit can be supplied with connectors explicitly specified by the customer. For more information please refer to AEQ sales department or authorised distributors.

### 2.2.2.5. Control and studio headphones.

AEQ FORUM includes studio and control headphones outputs on asymmetric connection, 1/4" (6,3 mm) Phone Jack Connectors.

The control headphones output is identified as "**PHONES**" in the "**CONTROL ROOM**" section on the rear panel of the equipment.

The studio headphones output is identified as "**PHONES**" in the "**STUDIO ROOM**" section on the rear panel of the equipment.

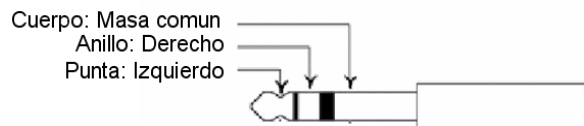

### 2.2.2.6. Orders microphone.

Talk-back or orders microphone input is identified as "**T'BACK MIC**" in the "**CONTROL ROOM**" section on the rear panel of the AEQ FORUM. The input includes MIC/LINE and Phantom ON/FF selectors.

XLR - Female 3p. Balanced connection.

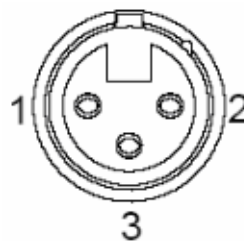

Pin 1 → GND  
Pin 2 → Input +  
Pin 3 → Input -

### 2.2.2.7. Optional MADl communications module.

On the rear panel of AEQ FORUM you can find the physical connector for the AES10 - MADl interface built into the console. The connector is an SFP chassis (Small Form-Factor Pluggable - SFP) where you allocate the optional fiber-optic transceiver.

MADl protocol, which stands for multichannel audio digital interface is a professional standard of data transmission for digital audio signals over 56 channels on a single cable. MADl protocol is documented in the standard AES10-1991 and ANSI s4.43-1991.

AES10 MADl multichannel interface is an extension of AES3 protocol for interconnection of multi-channel. MADl protocol, as defined in the AES10 standard allows connection of up to 64 audio channels (linearly quantified data) with a resolution of 24 bits per sample and a sampling rate frequency of 48 kHz/s. Transmission is accomplished in a serial mode and if transmission is done on a single 75 ohm coaxial cable with BNC connectors the distance reached is greater than 50 m. If transmission is accomplished on a multi-mode fiber-optic interface the distance is up to 2 km.



The audio samples may have a maximum of 32 bit quantization. Additionally, by using this protocol, the bits of validity user status and parity of AES3 are maintained. The MADl protocol allows you to connect 64 audio channels with a single pair of wires. The data bit rate is 100 Mbits/s corresponds to a synchronous connection.

MADl Interface Specifications:

- Optical fiber connector, FDDI PMD type.
- Nominal range: 2.000 meters
- Fiber Type: 62.5 / 125 µm MULTIMODE MULTIMODO
- Transmission: LED, 1300 nm

**NOTE:** in order to activate this function you must purchase a user license.

### 2.2.3. Audio inputs/outputs modules. C

FORUM AEQ includes enough space in its rear panel to accommodate a maximum of 14 independent modules of audio inputs and/or outputs in various formats. Depending on the type of audio processed, each of these modules receives a specific identifier within the family of products AEQ FORUM. AEQ is continuously developing new features for AEQ FORUM in order to meet the market demands for different solutions.

Below is the list of modules currently available:

- **FR02:** 4 inputs and 4 outputs, digital stereo AES/EBU or SPDIF module.
- **FR03:** 2 mic/line (selectable) inputs module.
- **FR04:** 8 analogue mono line level inputs module.
- **FR05:** 8 analogue mono line level outputs module.
- **FR22:** 4 inputs and 4 outputs, digital stereo USB module.
- **FR33:** digital telephone hybrid module.

Using the modules described above, in the numbers and available free position of the 14 available slots on the rear panel of AEQ FORUM, each customer can customize their AEQ FORUM mixing console to exactly fit its specific requirements and applications.

In order to simplify the installation phase, AEQ offers a prefabricated wiring kits for the different audio inputs and outputs modules available. More information in section 2.2.4 of this manual.

### 2.2.3.1. FR02 Digital inputs/outputs module.

The AEQ FORUM FR02 module includes 4 AES/EBU or SPDIF stereo digital inputs and 4 AES/EBU or SPDIF stereo digital outputs on two DB15 connectors.



The 4 digital inputs on the FR02 are available through a female DB15 connector identified as “AES/EBU 4 STEREO INPUTS”. The 4 digital outputs on the FR02 are available through a male DB15 connector identified as “AES/EBU 4 STEREO OUTPUTS”.

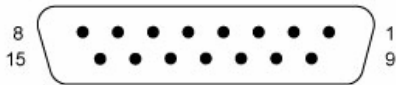

DB15 female connector pin-out detail

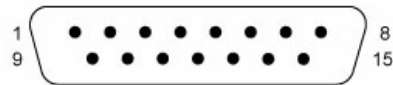

DB15 male connector pin-out detail

Pin	AES/EBU 4 STEREO INPUTS connector
1	IN1+
2	GND
3	IN2+
4	GND
5	IN3+
6	GND
7	IN4+
8	GND
9	IN1-
10	GND
11	IN2-
12	GND
13	IN3-
14	GND
15	IN4-

Pin	AES/EBU 4 STEREO OUTPUTS connector
1	OUT1+
2	GND
3	OUT2+
4	GND
5	OUT3+
6	GND
7	OUT4+
8	GND
9	OUT1-
10	GND
11	OUT2-
12	GND
13	OUT3-
14	GND
15	OUT4-

The module FR02 includes SRC (Sample-Rate-Converters) for all inputs and outputs. The digital audio format for each input or output is irrelevant in the process of installation and configuration since it is being managed automatically and transparently to the user.

By changing some jumpers on the FR02 module you can work with digital signals in SPDIF format. In the module you can see, for each one of the 4 inputs and 4 outputs, the jumpers position in order to configure them as AES3 or SPDIF.

### 2.2.3.2. FR03 Mic/Line inputs module.

The AEQ FORUM FR03 module includes 2 switchable monophonic microphone/line level on two female XLR connectors.



Each of the two Mic/Line inputs available on the FR03 module includes separate controls on dedicated hardware button to select your operation as microphone or line input, as well as the activation or deactivation of the +48V **Phantom** power available. The modification or activation of any of these options can be monitored from the internal menu available in the main screen of the Control and Monitoring section and monitors in the control surface FORUM AEQ. For more information see section “3.4.3.1.3. Expanded information menu“ in this manual.

XLR - Female 3p. Balanced connection.

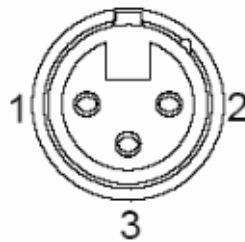

- Pin 1 → GND
- Pin 2 → Input +
- Pin 3 → Input -

**NOTE 1:** the physical location of the FR03 modules present in a normal configuration of AEQ FORUM is limited to the first 4 of the 14 available slots on the rear panel of console. Therefore, the maximum number of microphones present in any AEQ FORUM console is 9, 8 through the FR03 modules connected and one more microphone connected to “T’BACK MIC” input.

**NOTE 2:** in case you use a microphone that needs **Phantom** power, it’s important that you activate that option only when the microphone is already connected to the corresponding input, in order to avoid unconfigure the gain of the rest of the microphones (anyway it’s possible to recover those gains configuration just by refreshing the gain of at least one microphone per module).

### 2.2.3.3. FR04 Analogue line inputs module.

The AEQ FORUM FR04 module incorporates 8 electronically balanced monophonic line level inputs and are available physically through two DB15 female connectors identified as “ANALOG INPUTS 1 To 4” (upper) and “ANALOG INPUTS 5 To 8” (lower).

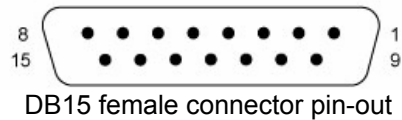
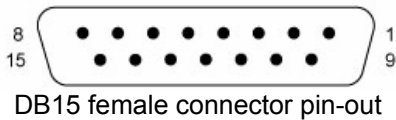

Pin	ANALOG INPUTS 1 To 4 connector
1	IN1+
2	GND
3	IN2+
4	GND
5	IN3+
6	GND
7	IN4+
8	GND
9	IN1-
10	GND
11	IN2-
12	GND
13	IN3-
14	GND
15	IN4-

Pin	ANALOG INPUTS 5 To 8 connector
1	IN5+
2	GND
3	IN6+
4	GND
5	IN7+
6	GND
7	IN8+
8	GND
9	IN5-
10	GND
11	IN6-
12	GND
13	IN7-
14	GND
15	IN8-

Depending on the specific application or installation required, the 8 monophonic inputs can be configured as 4 stereo inputs using the configuration software. For more information see section “4.2.3. I/O Configuration submenu” of this manual.

### 2.2.3.4. FR05 Analogue line outputs module.

The AEQ FORUM FR05 module incorporates 8 electronically balanced monophonic line level outputs and are available physically through two DB15 male connectors identified as “ANALOG OUTPUTS 1 To 4” (upper), and “ANALOG OUTPUTS 5 To 8” (lower).

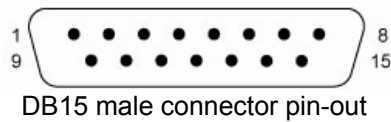
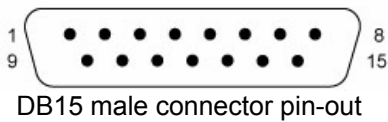

Pin	ANALOG OUTPUTS 1 To 4 connector
1	OUT1+
2	GND
3	OUT2+
4	GND
5	OUT3+
6	GND
7	OUT4+
8	GND
9	OUT1-
10	GND
11	OUT2-
12	GND
13	OUT3-
14	GND
15	OUT4-

Pin	ANALOG OUTPUTS 5 To 8 connector
1	OUT5+
2	GND
3	OUT6+
4	GND
5	OUT7+
6	GND
7	OUT8+
8	GND
9	OUT5-
10	GND
11	OUT6-
12	GND
13	OUT7-
14	GND
15	OUT8-

Depending on the specific application or installation, the 8 mono outputs can be configured as 4 stereo outputs from the configuration software. For more information see section “4.2.3. I/O Configuration submenu” of this manual.



### 2.2.3.5. FR22 USB inputs/outputs module.

The AEQ FORUM FR22 module includes 4 USB stereo digital inputs and 4 USB stereo digital outputs on four female USB B type connectors.

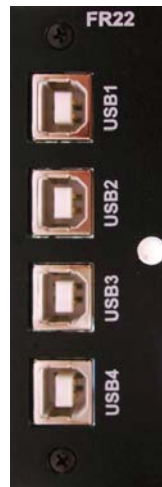

One stereo digital input and one stereo digital output are available through each one of the four USB connectors.

When you connect a USB module to a PC through any of the USB ports, the PC will automatically recognize it as a new audio device (it will be shown as “USB Audio CODEC”). To this device you can send audio from any audio playback application in the same way as if it was an external professional audio board. It is also possible to record any audio from the mixing console in the computer by using any recording application.

These boards are “plug&play” on Microsoft Windows™ and Apple Computer Mac OS™ operative systems, no specific driver is needed. When you connect several USB ports from one or several USB modules to the same PC, the operative system will show a new audio device for each one, that will be identified as “USB Audio CODEC”, “USB Audio CODEC (2)”...

Supported sampling frequencies are 32 KHz, 44.1 KHz and 48 KHz, with sampling rate converters (SRC) to 48 KHz that corresponds to the internal sampling rate of the system.

### 2.2.3.6. FR33 Telephone hybrid module.

The AEQ FORUM can incorporate up to two modules FR33 as internal digital telephone hybrids, each of which have the capacity to manage a single telephone line.

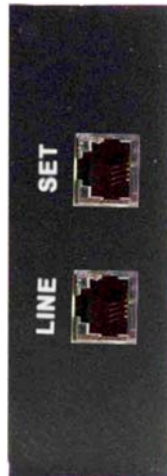

Each FR33 module includes two RJ11 connectors, one is labelled “**LINE**” and to which the telephone line connection is accomplished. The other is labelled as “**SET**” and used to connect an external telephone terminal from where you can dial the required number or answering a call prior to placing the call ON-AIR.

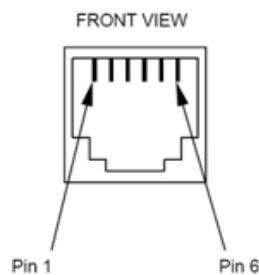

RJ11 connector

The configuration of the signals present in the FR33 module and associated controls is accomplished from the configuration software. For more information, please refer to chapter “4.2. Hardware Configuration menu” of this manual.

Depending on the version of firmware installed the configuration options related to the FR33 Digital Telephone Hybrid module may not be available. It may be necessary to use external communication devices and for which the programmable keys of the AEQ FORUM can be used. For more information please refer to section “4.3.2.4. Configuration of Codec programmable keys” of this manual.

#### 2.2.4. Wiring.

All wiring kits described below are optional and have been designed by AEQ to simplify the installation of the unit. To facilitate the quick connection of the console in almost any installation, AEQ can supply audio and data cables with the corresponding DB-type connectors that are used to connect the unit. These cables can be cut to desired lengths and soldered on patch panels, punched into connector strips or fitted with the corresponding connectors to be used directly connected to the peripheral equipment.

- CAB FR GPI: DB9 male connector connected to a 4-meter cable with open-end termination, for GPI.
- GPO CAB FR: DB9 female connector connected to a 4-meter cable with open-end termination, for opto-coupled GPO's.
- GPR CAB FR: DB9 female connector connected to a 4-meter cable with open-end termination, for physical contact (relay) GPO's.
- FR CAB MON:DB9 female connector connected to a balanced and shielded four pair, 4-meter cable with open-end termination, for 2 monitor outputs.
- FR CAB INP: DB15 male connector connected to a balanced and shielded four pair, 4-meter cable with open-end termination, for 4 audio inputs.
- FR CAB OUT: DB15 female connector connected to a balanced and shielded four pair, 4-meter cable with open-end termination, for 4 audio outputs.

AEQ can upon request provide fully finished cables and in special lengths. For more information please refer to AEQ sales department or authorised distributors.

### 3. DESCRIPTION OF THE INTERNAL MENU.

The AEQ FORUM internal menu is displayed on the main screen of the Control and Monitoring section of the control surface.

Most of them allow you to modify the values shown (although some screens of the internal menu are merely informative), changing routing, gains or applying processes to the audio signals. For this purpose, the three rotary encoders and the four contextual keys associated to this screen will be used.

Depending on the information shown on the last line of the menu display, the four contextual keys immediately beneath the display will have different functions. This last line of the menu will have a maximum of four visible options.

The three rotary encoders are associated with the options shown in the menu (each specific screen will be explained in detail later in this manual). The specific association of the encoders is following the next thumb rule: the menu option that is shown farthest to the left or in the highest position is controlled from the encoder located farthest to the left.

The default screen in AEQ FORUM shown in the main Control and Monitoring section display includes the AEQ logo, the product name, the active user level and current date and time.



The four options visible on the last line of the display are associated with the four contextual keys below, from left to right:

- **“CLOCK”**: allows you to access to the system date and time configuration menu, as well as to the chronometer and countdown available functions.
- **“LOGOU”/“LOGIN”**: allows you to access to the users registration menu (“LOGIN”) or leave the current active user (“LOGOU”).
- **“MEMORY”**: allows you to access to the system snapshot memory bank. There are 7 memory positions available in order to store different configurations.
- **“MENU”**: allows you to access to the advanced menu for audio inputs/outputs, routing and processing configuration.

In the upper right part of the display the level of the active user is shown (it changes between **“BASIC”**, **“ADVAN”** and **“ADMIN”**). For more information, please refer to section **“3.2. LOGIN/LOGOUT menu”** of this manual.

#### 3.1. “CLOCK” menu.

This menu enables you to set the date and time displayed in the system (but not the option of synchronization with a external master clock, which is only configurable from the configuration software: see section 4.2.5 in this manual), as well as activate and control the Chronometer and Countdown functions.

The initial screen shows the current system time (HH/MM/SS) and, up on the right, the date (DD/MM/YY).



The four options visible on the last line of the display are associated with the four contextual keys below, from left to right:

- **“BACK”**: returns to the previous menu screen.
- **“SET”**: enables you to access to the date and time configuration menu. When you access to this menu, the **time configuration** is available (a flashing arrow is displayed next to the current time) by means of using the 3 rotatory encoders (turning the first one allows you to change the hour, the second one the minutes and the third one the seconds).

When you press the **“DATE”** contextual key, you access to the **date configuration** menu (the flashing arrow changes its position and the **“DATE”** changes to **“TIME”**): by pressing the first encoder you can change between day of the week and day of the month and by turning it allows you to change the selected option; you can configure the month by turning the second encoder and the year by turning the third one.

Once date and time are configured, you can press the **“SET”** key in order to save the changes and return to the previous screen or the **“BACK”** key in order to return to that screen without changes saving.

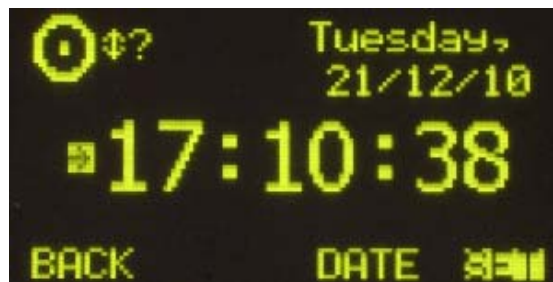

- **“CDOWN”**: lets you configure and activate the AEQ FORUM Countdown option through the associated rotary encoders. The format on screen is HOURS:MINUTES:SECONDS. You can configure the hours by turning the first encoder, the minutes by turning the second one and the seconds by turning the third one. The **“START”** contextual key launches the countdown, the **“STOP”** key (the same key that changes its function) brings it to a stop, and the **“RESET”** key re-establishes the initially configured value (even when the countdown is launched). The **“BACK”** key allows you to return to the previous screen (it also stops the countdown and re-establishes the initial value).

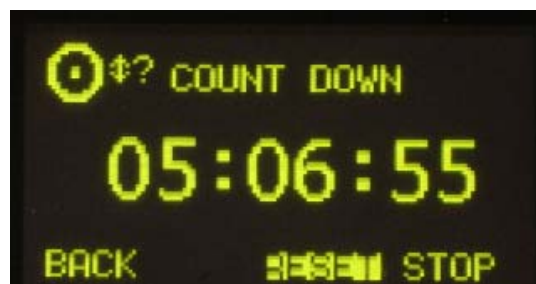

- **“CHRONO”**: enables you to configure and activate the chronometer option. The format on screen is HOURS:MINUTES:SECONDS.  
The **“START”** contextual key initiates the chronometer, the **“STOP”** key (the same key that changes its function) stops it, and the **“RESET”** key re-establishes the initial zero value (even when the chronometer is launched). The **“BACK”** key allows you to return to the previous screen (it also stops the chronometer and re-establishes the initial zero value).



### 3.2. “LOGIN/LOGOUT” menu.

This menu allows AEQ FORUM users/operators to register in the system, so that the equipment recognizes their user level by the associated password, and assigns them an access level for subsequent operation in the different console submenus.

AEQ FORUM enables up to 4 different user levels, each with its associated profiles and passwords:

- **LEVEL 0**: users with no associated password. You can access to this level by pressing the **“LOGOU”** contextual key in the initial menu (that key changes to **“LOGIN”**). The operation is limited to raising and lowering faders, activate/deactivate the 4 routing keys and the CUE key of each channel, activate/deactivate channels (**“CHANNEL ON/OFF”**) and use the programmable keys and monitoring section. The **“SELECT”** key of each channel is not active and neither the options visible on the last line of the main menu (**“CLOCK”**, **“MEMORY”** and **“MENU”**); the **“LOGIN”** option is available in order to change user.
- **LEVEL 1**: these users are defined in the configuration software with **“Basic”** access level (see section 4.1.2 in this manual). In the initial screen, up on the right, the indication **“BASIC”** is shown to identify this level. These users may perform the same actions as the level 0 users, and can also activate equalizers and filters and modify audio input channels gains. They can't modify phase and balance, activate dynamics processes, modify the routing or modify the signal present in a certain channel. Only the **“LOGOU”** option is available in last line of the main menu in order to return to level 0 (and then, be able to change user by means of **“LOGIN”** option).
- **LEVEL 2**: these users are defined in the configuration software with **“Advanced”** access level (see section 4.1.2 in this manual). In the initial screen, up on the right, the indication **“ADVAN”** is shown to identify this level. These users may perform the same actions as the level 1 users, as well as all the additional operation, configuration and control options that AEQ FORUM control surface and its associated internal menu offers, except the change of the **IP addresses** of the two network ports (**“LAN”** and **“ETHERNET”**) present in the rear panel of the unit.
- **LEVEL 3**: these users are defined in the configuration software with **“Administrator”** access level (see section 4.1.2 in this manual). In the initial screen, up on the right, the indication **“ADMIN”** is shown to identify this level. This is the highest level in the system, reserved for administrators. It enables full access to all the equipment menus and configuration options (including the change of the **IP addresses** of the two network ports of the unit), and, in addition, is the only level enable to access to the configuration software. The same password is used in this menu integrated into the control surface and in remote configuration software. For more information, see section **“4. CONFIGURATION SOFTWARE”** in this manual.

The “**LOGIN**”/“**LOGOU**” contextual key has two possible uses: LOGIN to register yourself (depending on the password used you will access to a certain level) and LOGOUT to de-register (this way you gain access to level 0). When you register through the option “**LOGIN**”, the “**PASSWORD**” screen appears: six spaces are displayed on screen associated with the six digits (as maximum) of the password. The password must be configured previously from the configuration software (see section “**4. CONFIGURATION SOFTWARE**” of this manual). The password supplied by default for “**ADMIN**” user (LEVEL 3) is **1234**.



The procedure for entering the password requires the use of the contextual keys beneath the display and any of the three associated encoders.

By **turning** any of the 3 encoders you can select the desired digit; by **pressing** any of the 3 encoders you can confirm your selection as part of the password and change to the following position (when you press an encoder after selecting the sixth digit, it’s equivalent to press the “OK” key).

The four contextual keys are associated with the four options displayed in the bottom line of the display:

- “**BACK**”: pressing this key allows you to return to the previous menu screen.
- “**PREV**”: enables you to move to the left through the six positions that make up the password.
- “**NEXT**”: enables you to move to the right through the six positions that make up the password.
- “**OK**”: allows you to confirm that all the digits of the password have been entered and, if password is correct, change to the associated user (the main display shows then the initial AEQ FORUM screen with the user level up on the right and the second contextual key identified as “**LOGOU**”). When you enter an incorrect combination of digits, a “**WRONG PASSWORD**” message is displayed (the “**BACK**” key allows you to return to the previous screen in order to insert the password once again).





### 3.3. “MEMORY” menu.

This menu enables you to manage the configuration memories as snapshots. In two consecutive screens, the 7 memory positions available for user-defined configurations are shown.

Each one of these memory positions stores all of the parameters in use at that time in each one of the console channel: gain, phase and balance configuration, “PROGRAM”, “AUDITION”, “AUX1”, “AUX2” and/or “CUE” routing activation, configuration/activation of equalizers, filters and/or dynamics processes and channels activation/deactivation (ON/OFF). No fader position is stored, because these are set manually. The memory position also stores the activation of signals sending to control and studio monitoring (by means of the keys placed under the corresponding displays), but not the position of the 3 associated encoders.

The first of these screens displays the first 4 memory positions for user-defined configurations, and the second shows the following 3 memory positions. You can shift between these two screens by turning any of the associated encoders as you move through the complete list of snapshots stored at that time. The memory that is selected at any time is highlighted.

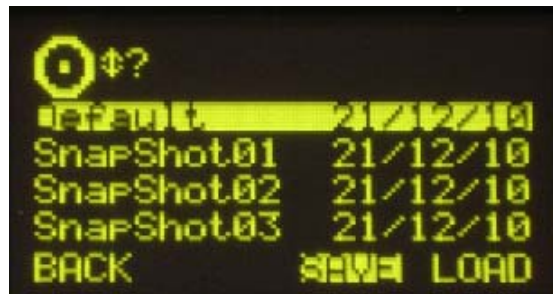

Each stored memory is identified by its name and the date on which it was created. The names of the memories are editable from the configuration software (see section 4.3.5 in this manual).

The options available through the contextual keys below the screen, from left to right, are:

- **“BACK”**: pressing this key allows you to return to the previous menu screen. No change you may have made is saved.
- **“SAVE”**: stores in the selected memory position the configuration of the console at that moment. The system will ask for your confirmation (in the screen that appears, you can confirm by pressing “SAVE” again or return to the memories list by pressing “BACK”).
- **“LOAD”**: allows you to load the configuration you stored previously in the selected memory position. The system will ask for your confirmation (in the screen that appears, you can confirm by pressing “LOAD” or return to the memories list by pressing “BACK”).

You can also create snapshots with different configurations from the configuration software. See section 4.3.5 of this manual.

### 3.4. “MAIN MENU “.

Pressing the “MENU” key in the initial screen will take you to the “MAIN MENU” screen. From this advanced configuration menu you can control, among other parameters, audio inputs/outputs, internal routing and processes. The four options visible on the last line of the display are associated with the four contextual keys below, from left to right:

- **“BACK”**: pressing this key allows you to return to the previous menu screen.
- **“INFO”**: essentially a maintenance menu displaying information about the IP addresses of the two network ports (“LAN” and “ETHERNET”) present in the rear panel of the unit and firmware versions installed in the several console operating modules, as well as the routing and process DSPs percentage of use.

- **“SETUP”**: which displays and allows you to change the IP configuration associated with the two Ethernet ports available on the rear panel of the equipment (“LAN” and “ETHERNET”: see section 2.2.2.2 of this manual) in the form of IP address (IP1 or IP2), subnet mask (MASK) and gateway (GWAY). Only level 3 users can modify these parameters (the “SETUP” key is shown to other users but is not active).
- **“SELECT”**: advanced configuration of audio inputs/outputs, internal routing and processes.



### 3.4.1. “INFO” menu.

This is a menu specifically for technical maintenance. The “INFO” menu lets you display the IP configuration associated with the two Ethernet ports available on the rear panel of the equipment (“LAN” and “ETHERNET”: IP address, subnet mask and gateway are shown), the firmware versions installed in the several console operating modules and the routing and process DSPs percentage of use.

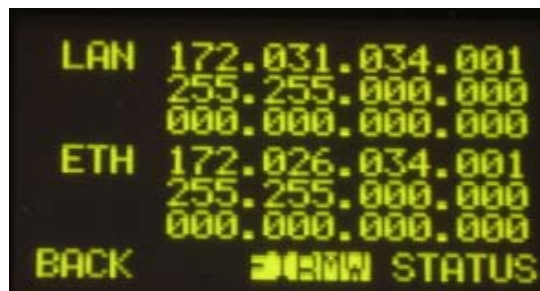

The three options visible on the last line of the display are associated with three of the four contextual keys below, from left to right:

- **“BACK”**: pressing this key allows you to return to the previous menu screen.
- **“FIRMW”**: in successive screens, which are accessed by turning any of the associated encoders, you can display the firmware versions installed in the different modules that make up the console: the 4 modules that make up the main board of the console (CPU, FPGA, Routing DSP and Process DPS) are shown as “MAIN BOARD” and the MSC module (control and monitoring section) and the FSC modules (4 faders modules or FRCH) are shown as “CONTROL SURFACES”.

Each line is identified by the specific module and its reference, as well as the version and the date of the currently installed specific firmware.

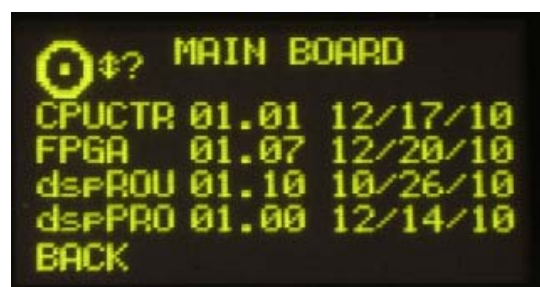

- **“STATUS”**: allows you to access to the information regarding the routing and process DSPs percentage of use.

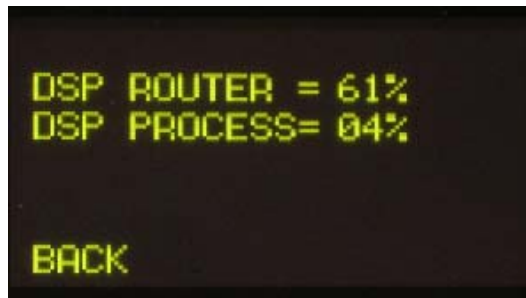

### 3.4.2. “SETUP” menu.

Through the **“IPSET”** option in a contextual key, this menu enables you to display and modify the IP configuration associated with the two Ethernet ports available on the back panel of the equipment (**“LAN”** and **“ETHERNET”**: see section 2.2.2.2 of this manual) in the form of IP address, subnet mask (MASK) and gateway (GWAY). Only level 3 users are allowed to modify these parameters (the **“SETUP”** key is shown to other users but is not active).

**IMPORTANT NOTE: the IP addresses of both Ethernet ports must not be configured into the same network.** For instance, if **“LAN”** port is configured with 172.31.34.1 IP address and 255.255.0.0 mask, the IP address of the **“ETHERNET”** port should be different from 172.31.x.x (where x is any number between 0 and 255).

As in many other AEQ FORUM console submenus, the icon in the upper left-hand corner indicates that browsing and configuration are performed by using the associated rotary encoders.



From left to right, the three rotary encoders are associated with **“IP”**, **“MASK”** and **“GWAY”** fields respectively. Each one of these fields consist of 4 number separated by dots and named bytes.

A flashing cursor indicates the byte that is subject to be changed at that moment by turning the associated encoder. Pressing any of the 3 encoders allows you to change from one byte to the next one. This process is repeated from left to right until the IP address is complete, as well as the associated subnet mask and gateway.

The **“OK”** contextual key allows you to validate and save the changes, returning then to the previous screen. The **“BACK”** contextual key allows you to return to the previous screen without changes saving.

The **“ETH”/“LAN”** contextual key allows you to alternate the on-screen presentation and, therefore, to edition of the IP configuration parameters associated with the two network ports available on the rear panel of the unit: **“LAN”** and **“ETHERNET”**.

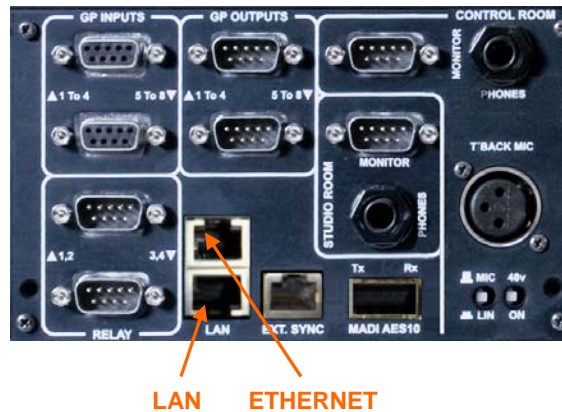

### 3.4.3. “SELECT” menu.

This menu enables you to perform advanced configuration operations on audio inputs/outputs, processes and internal routing of all of the signals present in the console.



The options available through the contextual keys below the screen, from left to right, are:

- “**BACK**”: pressing this key allows you to return to the previous menu screen.
- “**INPUT**”: configuration of input audio signals, as well as processes and routing associated with those signals.
- “**OUTPUT**”: configuration of output audio signals, as well as associated routing and tones activation.

#### 3.4.3.1. “INPUT” menu.

This menu shows a list of all the audio input logical signals defined in the system from the configuration software. For more information, see section “**4. CONFIGURATION SOFTWARE**” in this manual.

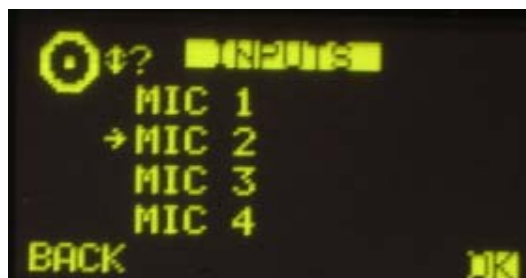

You can access a more complete description of each one of the input audio channels by turning any of the 3 associated encoders and pressing then the “OK” contextual key or any of these encoders. The information showed on this screen, from top to bottom and left to right, is:

- **Name of the channel**, in alphanumeric format containing up to 6 characters. This is the same identifier as the one shown in the channel display. See section “2.1.1.3. Channel display” in this manual.



- **Hardware** corresponding to the audio input of this channel, in format HW: xx.yy, where xx is the number of the slot where this inputs/outputs module is installed, and yy is the audio channel of this inputs/outputs module. In stereo channels, yy represents the audio channel corresponding to the left channel of the stereo pair. The right channel corresponds to the number just above.
- Graphic representation of three **encoders** associated with the **GAIN**, **PHASE** and **BALANCE** fields. By operating on the rotary encoders associated with the main screen in the Control and Monitoring section, you can change the values.
  - **GAIN**: configurable between -12dB and +12dB for line level inputs and between -36dB and +19dB for mic level inputs. The field is configured with the default value of 0dB. Any modification of the initial value of this gain will illuminate the dedicated “**GAIN**” LED on the corresponding fader of the control surface (see section “2.1.1.5. Indicators of active processes” of this manual).
  - **PHASE**: allows you to modify the input signal phase among +/+, +/-, -/+ and -/- for stereo signals, and among + and – for mono signals.
  - **BALANCE**: enables you to modify the balance between the L and R channels in stereo signals. The operation of this indicator will activate the dedicated “**BAL**” LED on the corresponding fader of the control surface (see section “2.1.1.5. Indicators of active processes” of this manual).

**NOTE:** When the input audio channel selected in the “INPUTS” list is assigned to a fader channel, you can also access to this advanced information screen by pressing the “**SELECT**” key of the corresponding channel (see section “2.1.1.2. **SELECT**” of this manual), working this key as a quick access to this submenu. Using any of both access ways, the LED of the “**SELECT**” will be activated.

The four contextual keys under the display are associated with the four options shown in the bottom line of the screen:

- “**BACK**”: pressing this key allows you to return to the previous menu screen.
- “**DYNAM**”: allows you to access to the menus for configuration and activation of dynamics effects included in AEQ FORUM: Compressor/Limiter and Noise Gate.
- “**EQUAL**”: allows you to access to the menu for configuration and activation of Equalizers and Filters included in AEQ FORUM.
- “**NEXT**”: allows you to access the additional information menú about the audio signal present in this input channel, where you can also change the signal assigned to that channel and modify its internal routing.



### 3.4.3.1.1. Dynamics menu: Compressor/Limiter and Noise Gate.

#### COMPRESSOR / LIMITER:

Pressing the “DYNAM” contextual key from the advanced information menu of an audio input channel will give you access to the menu to configure the Compressor/Limiter.

Dynamics processors are used to modify the dynamic ranges of an audio signal to adapt it to specific needs or to produce certain sound effects. A compressor enables you to reduce the dynamic range of the signal. Your purpose may be to adapt a signal with a very broad dynamic range to a circuit that will not support such wide variations in level, or to generate certain sonority in a signal.

The “**Compressor / Limiter**” function acts as a “constant gain” compressor; that is, below the threshold, all input signals are amplified (or not amplified) equally, while above the threshold, the input levels are reduced to a greater or lesser degree according to the compression ratio.

If the compression range selected is the maximum, the function will act as a limiter in such a way that the signals that exceed the selected threshold at input will not exceed a certain level at output. For example, with a threshold = 0 dB, a gain of 10 dB and a compression ratio of 1:50, you will ensure that all the signals that exceed 10 dB at input will also be output at 10 dB, while the signals that are below the threshold will have an overall gain of 10 dB.



From top to bottom and left to right, the information displayed on the Compressor/Limiter configuration and control screen comprehends:

- **“THR” (Threshold):** this is the threshold above which the compressor will act. Signal levels that exceed this threshold will be affected by the compressor settings. The threshold range varies from -42dB to +22dB.
- **“ATT” (Attack Time):** this is the time it takes the compressor to react to an increase in the input signal. The shorter this time, the more sensitive the compressor will be to pulse signals, and the higher the action on this type of signals. With a long attack time, the compressor will not respond so well to pulse changes in the input signal. It ranges between 0.5 and 95 ms.
- **“REL” (Release Time):** this is the maintenance time during which the compressor keeps acting, even when the level of the input signal has fallen below the threshold. A long release time will maintain uniform compression, even when there are quick level fluctuations in the signal. A short time will enable the compressor to adapt more quickly to pulse fluctuations in the signal. It ranges between 10 and 9500 ms.
- **“RAT” (Compression Ratio):** this is the compression ratio. A ratio of 1:1 does not involve any variation in the signal, as the level of the input signal is maintained at the output. A ratio of 2:1 indicates that the level of an input signal which exceeds the threshold will be reduced to half at the output. The highest ratio available is 50:1, which will be used to implement signal limiters. The limiter must reduce all signals exceeding a certain level to that level.
- **“G” (Gain):** this enables you to apply a general gain to the signal. This entails a general increase of the signal level, which will be especially noted at low input levels that are under the threshold set. A general increase in the level of the signal may generate saturation at the output, even when the signal is being limited. It ranges between 0 and +40dB.

A cursor blinks over the fields placed on the left or on the right to indicate the fields that can be modified at that moment. To change from the one to another just press any of the three associated encoders. When you select the fields on the left, turning the first encoder allows you to change “THR”, the second one changes “ATT” and the third one changes “REL”; when you select the fields on the right, turning the first encoder allows you to change “RAT” and the second one changes “G” (the third one has no function in this case).

NOTE: To correctly set a limiter, a threshold between 0 and +22 dB should be selected, with a compression ratio of 50:1 and a gain of 0 dB.

The “**COMP**” contextual key enables you to activate the compressor whose parameters are shown at that time on the screen. The activation of the compressor is confirmed by the activation of the **LED** of the contextual key and the **LED “DYN”** of the selected mixer channel (see section “**2.1.1.5. Indicators of active processes**” of this manual). The “**COMP**” contextual key also enables you to return to the Compressor/Limiter menu when you are in the Noise Gate menu (in that case, the associated LED lights for a moment and then it turns off).

IMPORTANT NOTE: The dynamics process, and especially the Compressor/Limiter, requires either extensive experience or caution and time to check, while off the air, the result obtained on the signal. Without these precautions, you may generate sound effects that can be perceived as dirty sound, lack of definition, distortion and other defects in general.

By pressing the “**NGATE**” contextual key you will access the screen dedicated to the control and configuration of the Noise Gate for that input channel (the associated LED lights for a moment and then it turns off).

#### NOISE GATE:

A noise gate is a dynamics processor that lets signals through whose level exceeds a certain threshold, strongly attenuating the signal levels below that threshold and thus muting noise. It enables its user to eliminate extraneous noise from a signal source, whether it is background noise in the studio, in the case of a microphone, or the background noise generated by a playback device, for example, a tape.

From top to bottom and left to right, the information shown in the Noise Gate configuration and control screen is as follows:

- “**ATT**”: Attack Time. It ranges between 0 and 95 ms.
- “**REL**”: Release Time. It ranges between 0 and 9000 ms.
- “**HOL**”: Hold Time. It ranges between 0 and 2000 ms.
- “**THR**”: Threshold. It ranges between -72 and 0dB.
- “**R**”: Range. It ranges between 0 and 90dB.

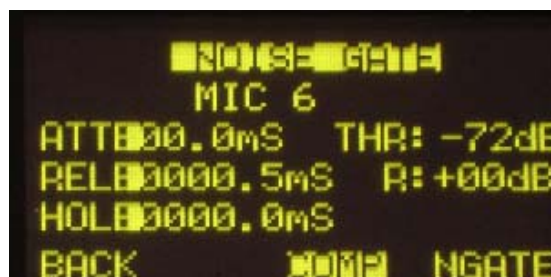

A cursor blinks over the fields placed on the left or on the right to indicate the fields that can be modified at that moment. To change from the one to another just press any of the three associated encoders. When you select the fields on the left, turning the first encoder allows you to change “ATT”, the second one changes “REL” and the third one changes “HOL”; when you select the fields on the right, turning the first encoder allows you to change “THR” and the second one changes “R” (the third one has no function in this case).



When establishing the settings, the threshold for the noise gate will be much lower than in the case of the compressor, as its operation is the opposite. The noise gate prevents the passing of lower levels of the signal that could be considered noise. Therefore, the range of settings is different. In addition, there is an additional parameter for noise gates, which is “Hold Time.” This is a safety period used to prevent the gate from accidentally closing if a signal is suddenly absent, for example, in speech.

In addition, the threshold must be adjusted to a level slightly higher than the level of the noise to be avoided. Thus, the threshold will be set at a very low level. Above the threshold, the noise gate does not act (unity gain), letting the rest of the signal through without processing it. The gate remains closed; i.e. when the signal surpasses the threshold level, the gate opens. The attack time is the time the gate takes to open (unity gain) when it receives a signal whose amplitude exceeds the threshold level; this time must be short to avoid cutting off the beginning of a sentence or song. The release time is the time the gate takes to close when the signal level falls below the threshold. The hold time is the minimum time during which the gate remains open; it is used to prevent the gate from closing when the signal level drops briefly—for example, when an announcer pauses while speaking. The hold time prevents the gate from opening and closing constantly in the presence of a signal whose level fluctuates in a range close to the threshold level.

The “**NGATE**” contextual key enables you to activate the noise gate whose parameters are shown at that time on the screen. The activation of the noise gate is confirmed by the activation of the **LED** of the contextual key and the **LED “DYN”** of the selected mixer channel (see section “**2.1.1.5. Indicators of active processes**” of this manual). The “**NGATE**” contextual key also enables you to return to the Noise Gate menu when you are in the Compressor/Limiter menu (in that case, the associated LED lights for a moment and then it turns off).

### 3.4.3.1.2 Equalizer and filter menu.

Pressing the “**EQUAL**” contextual key from the advanced information menu of an audio input channel will give you access to the menu to configure the equalizer and filters.

The upper part of the screen shows the channel identifier name and the middle area of the screen shows the graphic representation of the response curve of the equalizer and filters that are active at that time.



The four options visible on the last line of the display are associated with the four contextual keys below, from left to right:

- “**BACK**”: pressing this key allows you to return to the previous menu screen.
- “**HPF**”: allows you to activate the configured high pass filter (the associated LED will light). Pressing this contextual key for three seconds opens the cut-off frequency configuration menu: this configuration is accomplished by turning the first associated encoder and pressing the “**BACK**” contextual key to return to the previous screen once this parameter is configured (between 20 and 1000Hz).



- “**LPF**”: allows you to activate the configured low pass filter (the associated LED will light). Pressing this contextual key for three seconds opens the cut-off frequency configuration menu: this configuration is accomplished by turning the first associated encoder and pressing the “**BACK**” contextual key to return to the previous screen once this parameter is configured (between 1000 and 20000Hz).



- “**EQ**”: allows you to activate the equalizer whose frequency response is shown at that time on the screen (the associated LED will light). This frequency response is controlled from the associated encoders by working from left to right on the base, mid-range and treble bands, respectively. The frequency deviation permitted ranges from -18dB to +18dB (the default value is +0dB).  
Pressing this contextual key for three seconds opens the equalizer advanced configuration menu, where 3 rows appears for base (“**LOW**”), mid-range (“**MID**”) and treble (“**HIG**”) bands respectively. You can change from one band to another by pressing any of the three associated encoders. In the selected band (a flashing arrow is displayed), you can change the **central frequency** (“**F(Hz)**” column) by turning the first encoder, the **Q** (“**Q**” column) by turning the second encoder and the **gain** (“**G(dB)**” column) by turning the third encoder. The “**HPF**”, “**LPF**” and “**EQ**” contextual keys in this screen allows you to activate filters and equalizer; the “**BACK**” key allows you to return to the graphic configuration screen.

### 3.4.3.1.3 Expanded information menu.

Pressing the “**NEXT**” contextual key from the advanced information menu of an audio input channel will give you access to the advanced information section of that channel. It maintains a structure similar to the base menu. Information shown on this screen:

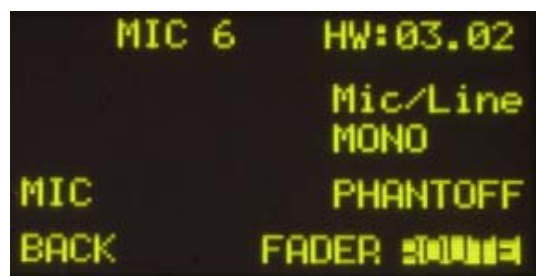

- **Name of the channel**, in alphanumeric format containing up to 6 characters. This is the same identifier as the one shown in the channel display. See section “**2.1.1.3. Channel display**” in this manual.
- **Hardware** corresponding to the audio input of this channel, in format HW: xx.yy, where xx is the number of the slot where this inputs/outputs module is installed, and yy is the audio channel of this inputs/outputs module. In stereo channels, yy represents the audio channel corresponding to the left channel of the stereo pair. The right channel corresponds to the number just above.
- **Channel typ**: mic/line, analogue, digital or USB.
- Indication of **MONO** or **STEREO** signal.
- In **mic/line** channels, indication of the position of the switch that selects the nominal level of the signal as mic or line (located in the relevant input module on the back panel of the unit). It changes from “MIC” to “LINE” and vice versa when you change the switch position.
- In **mic/line** channels configured as mic, indication of the position of the phantom power switch (located in the relevant input module on the back panel of the unit). It changes from “PHANTOFF” to “PHANTON” and vice versa when you change the switch position.

The contextual keys under the display are associated with the three options shown in the bottom line of the screen:

- **“BACK”**: pressing this key allows you to return to the previous menu screen.
- **“FADER”**: allows you to assign another input channel to the physical fader where this signal is currently found.
- **“ROUTE”**: gives you access to the menu for control and configuration of the internal routing of the equipment.

#### 3.4.3.1.3.1. “FADER” menu.

This submenu is displayed as a list of all the inputs available in the system (except the ones that are yet assigned to a fader). You can make your selection by turning any of the associated encoders and then pressing any of them or the “OK” contextual key to confirm the selection that is highlighted at that moment.

The “BACK” contextual key allows you to return to the previous menu screen without changing the assigned signal.

#### 3.4.3.1.3.2. “ROUTE” menu.

From this internal submenu you can manage the internal routing of signals in the console. You can access from the advanced information menu of an audio input channel and that submenu shows an alphabetical list of all of the outputs present in the console, followed by the internal summing buses (“Program”, “Audition”, “Aux1” and “Aux2”), the monitoring buses (“Cue”, “Studio” and “Control”) and finally the MPX buses.

The operation of the three associated encoders is as follows:

- **Left**: turning this encoder allows you to scroll through the several audio outputs and buses on the list. Pressing this encoder allows you to return to the previous menu screen (the changes you may have made are saved).
- **Centre**: turning this encoder has no associated function. Pressing this encoder allows you to return to the previous menu screen (the changes you may have made are saved).
- **Right**: turning this encoder enables you to modify the gain in the cross-point of the highlighted output or bus between -99.8dB and +12dB. By default, all of the cross-points will be configured with a 0dB gain. Pressing this encoder allows you to return to the previous menu screen (the changes you may have made are saved).



The operation of the contextual keys, from left to right, is as follows:

- **“BACK”**: pressing this key allows you to return to the previous menu screen (the changes you may have made are saved).
- **“ADD”**: enables you to create the cross-point toward the output signal or bus that is highlighted at that moment.
- **“DEL”**: enables you to delete the cross-point toward the output signal or bus that is highlighted at that moment.
- **“OK”**: pressing this key allows you to return to the previous menu screen (the changes you may have made are saved).

The routing toward the “Program”, “Audition”, “Aux1” and “Aux2” internal buses works in a different way depending on the assignment of the selected input to a fader or not:

- when the input is assigned to a fader and, in the previous list, you select “Program” bus (for instance), when you press the “ADD” key the routing key (“PROGRAM” in this case) of the channel is activated (the associated LED is lighted). In the display, the cross-point toward that bus appears for a moment and then disappears. The “DEL” key has no associated function in that case (you must press the “PROGRAM” channel key to deactivate that routing). If now you press the “ON” key of the channel, the cross-point appears now in the display (if you rise the fader, the “ON AIR” indicator will light); in that case, the “DEL” key allows you to deactivate the routing toward that bus (the cross-point disappears and the “PROGRAM” channel key turns off).
- when the input is not assigned to a fader and, in the previous list, you select “Program” bus (for instance), pressing the “ADD” key is equivalent to set that input “ON AIR” (the cross-point appears and, if gain is not configured at its minimum value, signal is sent to that bus). The “DEL” key allows you to deactivate that routing (the cross-point disappears).

### 3.4.3.2. “OUTPUT” menu.

This menu shows a list of all the audio output logical signals defined in the system from the configuration software, followed by the internal summing buses (“Program”, “Audition”, “Aux1” and “Aux2”), the monitoring buses (“Cue”, “Studio” and “Control”) and finally the MPX buses. For more information, see section “4. CONFIGURATION SOFTWARE” in this manual.

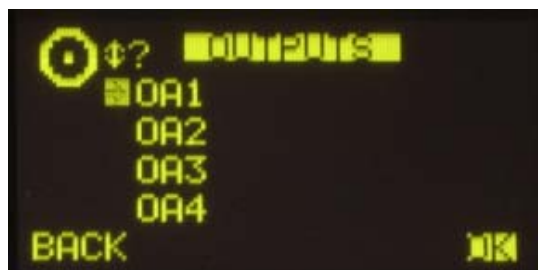

You can access a more complete description of each one of the output audio channels by turning any of the 3 associated encoders and pressing then the “OK” contextual key or any of these encoders. The information showed on this screen, from top to bottom and left to right, is:

- **Name of the channel**, in alphanumeric format containing up to 6 characters.
- **Hardware** corresponding to the audio output of this channel, in format HW: xx.yy, where xx is the number of the slot where this inputs/outputs module is installed, and yy is the audio channel of this inputs/outputs module. In stereo channels, yy represents the audio channel corresponding to the left channel of the stereo pair. The right channel corresponds to the number just above.
- Graphic representation of an **encoder** associated with the **GAIN** field. By turning the first associated encoder you can configure gain between -12dB and +12dB. The field is configured with the default value of 0dB.
- Indication of audio signal type: analogue or digital.
- Indication of **MONO** or **STEREO** signal.



The contextual keys under the display are associated with the three options shown in the bottom line of the screen:

- **“BACK”**: pressing this key allows you to return to the previous menu screen. The gain configuration you may have made is saved. You can also return to the previous screen by pressing any of the three associated encoders.
- **“TONE”**: controls the 1KHz calibrated tone generator associated with that physical output. Its activation is identified through the **LED** of the contextual key. To modify its level, you need only to change the output gain associated with that channel from the rotary encoder associated with “GAIN” control.
- **“ROUTE”**: this submenu allows you to manage the internal routing of the signals in the console toward that output signal or bus. It is displayed as a list of all the inputs channels connected to that output at that moment. By turning the first encoder you can go round the cross-points list. You can activate or deactivate the selected routing by means of “ADD” and “DEL” contextual keys and you can modify the cross-point gain (between -99.8dB and +12dB) by turning the third encoder.



#### 4. CONFIGURATION SOFTWARE.

The AEQ FORUM console is ready for use once the mixer inputs and outputs have been properly connected.

The console is shipped with the Audio inputs/outputs modules as requested by each customer. However, the name tags used for the channel audio inputs and outputs are generic (MIC 1, ANA 3, DIG 5 ...) and routing and effects programmed are AEQ standards that are used for functional testing of the console, whereas these settings may not be entirely to the preferences of the client.

This equipment is delivered with a Configuration Software for Windows 2000, XP, Vista or 7.

This configuration software allows the user to modify the original configuration to its exact requirements at any time.

The auto run disk furnished with the console contains the executable file that installs the configuration software. You can find it going through the following screens:



Installing the application is simply a matter of executing this file and following the on-screen instructions as they come up.

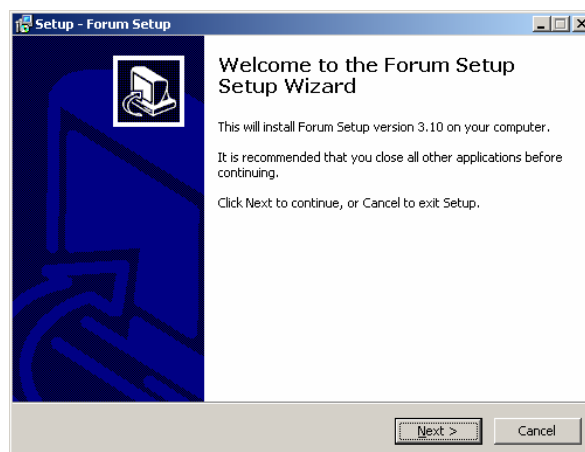



Once the “**Forum Setup**” application is installed (by default, in C:\Program files \ForumSetup), you can start it up by double-clicking the icon displayed on the desktop:



The configuration program will also be accesible from the Start menu.

When the application starts up, the access screen will appear asking user to introduce name and password.



Only the users defined as administrators (“Administrator” access level) can access to this application. User and password supplied by default are:

**Login:           ADMIN**  
**Password:       1234**

You may modify these parameters later in the “Administration” → “User Configuration” menu of the application. Please refer to section 4.1.2 of this manual.

After entering the correct user-name and password, the program shows the main-screen where you can access the different options.

There are two main areas in this workspace:

- Left side of the screen: pull-down menus and submenus area.
- Right side of the screen: larger area containing parameter settings for each of the menus and submenus.





This initial screen shows information regarding the software version and the current user logged into the application. On the left side of the screen all the relevant menus and submenus are available. These are drop-down menus and are activated by clicking on the desired option.

The list of available menus is:

- **“Administration”**: manage from here the equipment operational levels, authorised users of the mixing console and the communication between the remote configuration software and the mixer.
- **“Hardware Configuration”**: allows you to configure the physical audio inputs and outputs modules that are installed in the mixer and the logical audio channels that are created based on these. Further, the configuration of the monitoring sections and time synchronization are accomplished from here.
- **“Programmable Configuration”**: allows you to configure the internal routing of audio signals and the functions associated with the programmable keys, as well as define mics groups, create processes presets and manage the configuration memories (snapshots) of the unit.
- **“Firmware Upgrade”**: is a maintenance menu to accomplish future firmware upgrades of the mixer.

To exit the application, simply press the exit icon located in the upper right corner of the screen. The application will ask for confirmation to close.

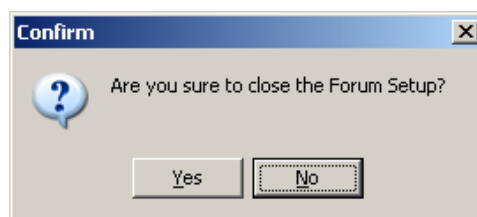

#### 4.1. “Administration” menu.

This menu allows you to manage levels of users that can operate the mixer and control the communication between the remote configuration software and the mixer. Clicking on the “Administration” section of the main screen the complete list of submenus is shown:

- **“Configurations”**: allows you to manage the configuration exchange between the software application and the AEQ FORUM.
- **“User Configuration”**: allows you to define the users (and their associated access levels) to operate the AEQ FORUM.
- **“About Forum Setup”**: this screen shows information regarding the software version and the current user logged into the application.

##### 4.1.1. “Configurations” submenu.

“Configurations” submenu is accessed, from the drop-down menu “Administration”, by clicking on the icon:



“Configurations” submenu handles the exchange of configurations created in the software application between this software and the AEQ FORUM mixer.

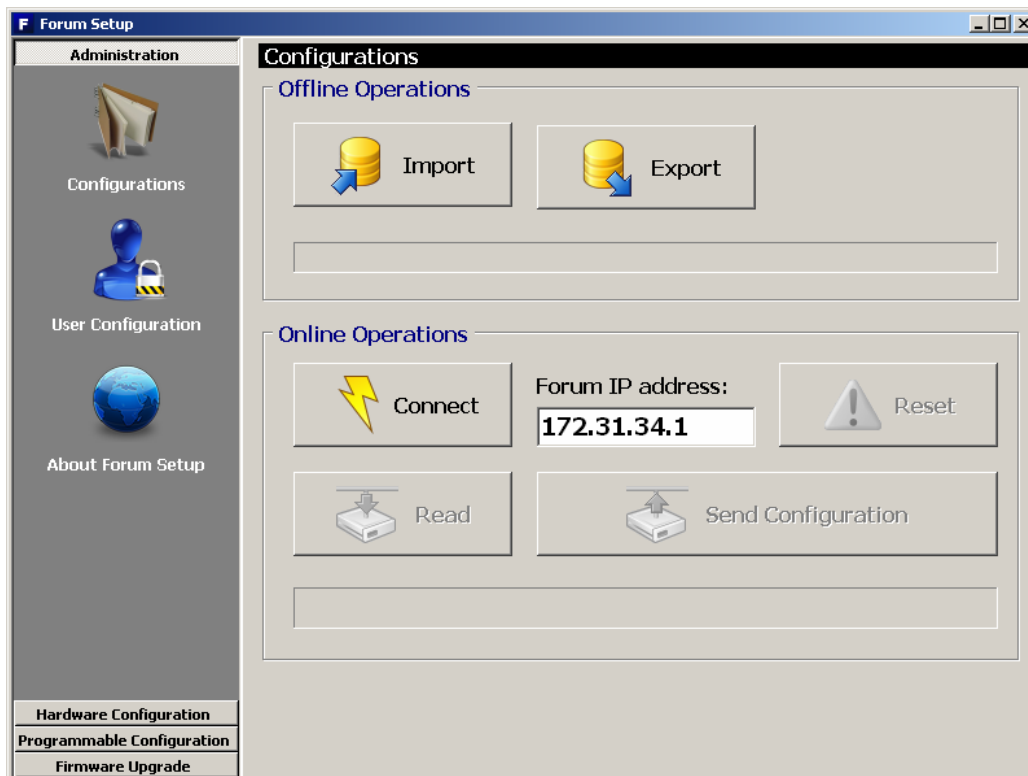

There are two distinct areas in this submenu:

- **“Offline Operations”**: allows you to execute actions where it is not necessary that the Forum Setup application is in direct communication with the AEQ FORUM mixer. There actions are available:
  - **“Import”**: allows you to load in the application complete configurations previously stored in a source file. By clicking the “Import” button, a standard Windows “browse for file” window will open to locate the file to import. The files must be of the proprietary type **FSC** (Forum Setup Configuration). These files are encrypted for reasons of security. You can find the “DemoConfiguration.FSC” file in C:\Program files \ForumSetup\Demos.  
**IMPORTANT NOTE:** when you load a configuration using this option, the active configuration at that moment in the application is overwritten and get lost (unless you previously save it by means of “Export” option). Therefore, you will be asked for confirmation:

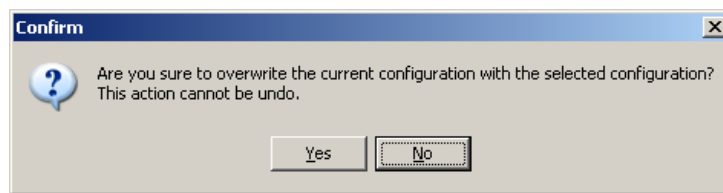

- **“Export”**: allows you to download the complete configuration, as shown in the application at any given moment, to a target file. Clicking on the “Export” button a standard Windows “save as” window will open allowing you to choose the folder and output file name to be stored. These files will have the **FSC** extension.
- **“Online Operations”**: allows you to execute actions where it is necessary that the Forum Setup application is in direct communication with the AEQ FORUM mixer, which “LAN” port, located on the rear panel of the mixer, has the default IP address displayed on the screen. When the connection is made through the “ETHERNET” port, the default IP address is 172.26.34.1. The “Connect” button initiates the communication process between the Forum Setup application and the AEQ FORUM Mixer. If the connection is established correctly the 3 associated buttons become active and the “Connect” button changes to “Disconnect” (and allows you to end that communication).

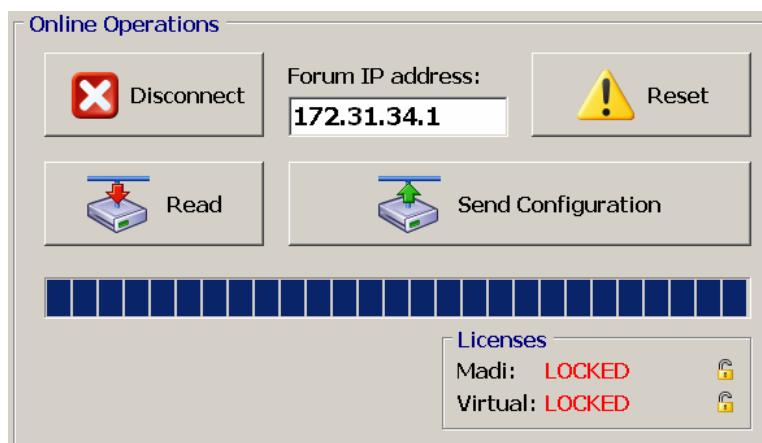

The associated buttons functions are the following ones:

- **“Read”**: allows you to read the configuration currently active in the AEQ FORUM mixer and download it in the Forum Setup application.  
**IMPORTANT NOTE:** the active configuration at that moment in the application is overwritten and get lost (unless you previously save it by means of “Export” option).

- **“Send Configuration”**: allows you to send the currently selected configuration to the AEQ FORUM mixing console, thus becoming the valid configuration in operation. The audio will be interrupted a few seconds while the new configuration is being activated. During the sending, a bar shows the process. If the process is properly done, the message **“Send Configuration: OK”** is displayed.
- **“Reset”**: replaces the currently active configuration on the AEQ FORUM mixing console with the configuration stored in the first memory or snapshot defined (please refer to section 4.3.5 of this manual). The audio will be interrupted a few seconds while the new configuration is being loaded.
- **“Licenses”**: allows you to activate the MADI link function or the “Virtual Forum” remote control software (this one is not available yet). For both options, you must purchase a user license  
 When you press the padlock associated to any of the 2 options, a window will appear allowing you to introduce the key associated to MADI function

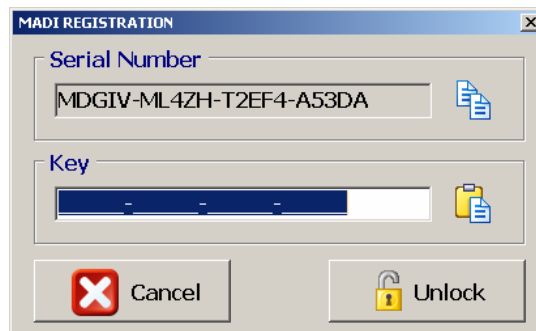

or the one associated to “Virtual Forum” application (available in future software versions):

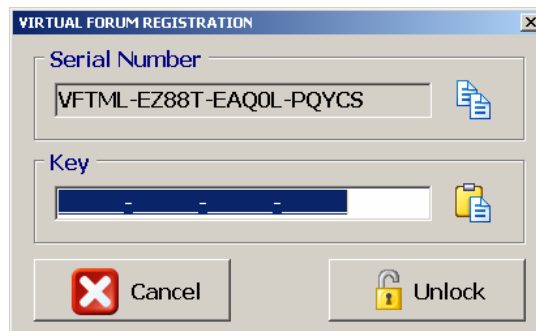

The **“Unlock”** button allows you to confirm the key and, when it’s correct, activate the function. In case the key is not the right one, an error message will appear:



**NOTE:** in case there is no connection to the mixer, those options are not activated and the following message is displayed:



#### 4.1.2. “User Configuration” submenu.

“User Configuration” submenu is accessed, from the drop-down menu “Administration”, by clicking on the icon:









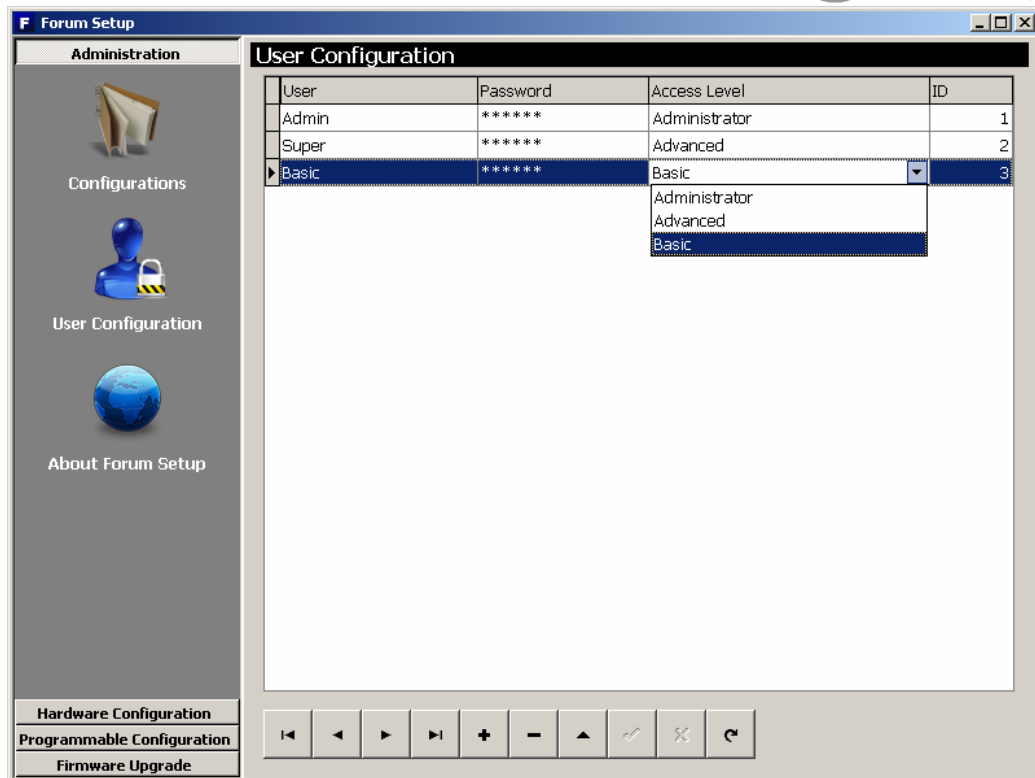



“User Configuration” submenu allows you to set access levels and create users to operate the AEQ FORUM mixing Console.

The display in this submenu shows the list of registered users and their associated parameters:

- **“User”**: alphanumeric name of the user. The maximum number of digits is limited to 32.
- **“Password”**: password associated with the user: number combination of up to 32 digits from zero to nine, although a **maximum of 6 digits** is recommended (a password with more than 6 digits could be used just to access the software, but couldn’t be used in the console). This password is used to access all the permitted actions in advanced menu, from the main screen of the Control and Monitoring section of AEQ FORUM. For more information see section 3.2 of this manual.
- **“Access Level”**: user level associated with the name and password previously configured (you can check the password associated to a user by means of edition button). FORUM AEQ allows up to 4 different users levels:
  - **LEVEL 0**: users with no associated password. The operation is limited to raising and lowering faders, activate/deactivate the 4 routing keys and the CUE key of each channel, activate/deactivate channels (“CHANNEL ON/OFF”) and use the programmable keys and monitoring section. It’s not possible to define users of this level in the configuration software (you can access to this level in AEQ FORUM console by pressing the “LOGOU” contextual key in the initial menu).
  - **LEVEL 1**: these users may perform the same actions as the level 0 users, and can also activate equalizers and filters and modify audio input channels gains. They can’t modify phase and balance, activate dynamics processes, modify the routing or modify the signal present in a certain channel. These users are defined in the configuration software with **“Basic”** access level and the indication “BASIC” is shown in the initial screen of the control surface to identify this level.
  - **LEVEL 2**: these users may perform the same actions as the level 1 users, as well as all the additional operation, configuration and control options that AEQ FORUM control surface and its associated internal menu offers, except the change of the **IP addresses** of the two network ports (“LAN” and “ETHERNET”) present in the rear panel of the unit. These users are defined in the configuration software with **“Advanced”** access level and the indication “ADVAN” is shown in the initial screen of the control surface to identify this level.
  - **LEVEL 3**: this is the highest level in the system, reserved for administrators. It enables full access to all the equipment menus and configuration options (including the change of the **IP addresses** of the two network ports of the unit), and, in addition, is the only level enable to access to the configuration software. The same password is used in this menu integrated into the control surface and in remote configuration software. These users are defined in the configuration software with **“Administrator”** access level and the indication “ADMIN” is shown in the initial screen of the control surface to identify this level. The password supplied by default for **“ADMIN”** user is **1234**.
- **“ID”**: internal referente number for each user automatically and sequentially assigned.



The lower part of the “User Configuration submenu includes a set of standardized buttons to manage the list of registered users:

-  Allows you to scroll to the top of the list.
-  Allows you to move to the position immediately above in the list.
-  Allows you to move to the position immediately below in the list.
-  Allows you to scroll to the last position of the list.
-  Allows you to insert a new entry in the list.
-  Allows you to delete the selected entry from the list. Confirmation is requested.
-  Allows you to edit the selected entry and check the password associated to that user.
-  Allows you to accept changes to the selected entry.
-  Allows you to reject to the selected entry.
-  Allows you to refresh the information shown in the list.

#### 4.1.3. “About Forum Setup” submenu.

“About Forum Setup” submenu is accessed, from the drop-down menu “Administration”, by clicking on the icon:



“About Forum Setup” submenu simply shows information regarding the software version and the current user logged into the application.



#### 4.2. “Hardware Configuration” menu.

This menu allows you to configure the system inputs and outputs modules as well as the logical audio channels created from the physical inputs and outputs. Clicking on the “Hardware Configuration” section on the left side of the screen displays the full list of submenus, which includes:

- **“Board Configuration”**: allows you to define the settings of faders, audio inputs/outputs modules and GPIOs of the Mixing Console.
- **“Mixer Bus Configuration”**: allows you to define the configuration of the internal summing buses of the mixing console.
- **“I/O Configuration”**: enables the configuration of logical audio channels based on the physical audio inputs and outputs as defined in the “Board Configuration” submenu.
- **“Monitoring Configuration”**: allows you to define the operation of the Control and Monitoring sections that are associated to the control and studio rooms.
- **“NTP Client”**: allows you to configure and activate time and date synchronization with a remote NTP server. Once configured this server will work as the master clock for the local time of the AEQ FORUM.



**IMPORTANT NOTE:** In order to access to any of these submenus, it's necessary to have a configuration loaded in the application (in case there's no configuration, the message **"Empty configuration. Please read configuration before use"** is displayed). Therefore, you have to either connect to AEQ FORUM console and read its configuration or load a configuration by means of "Import" option (see section 4.1.1 of this manual; you can find the "DemoConfiguration.FSC" file in C:\Program files \ForumSetup\Demos).

#### 4.2.1. "Board Configuration" submenu.

"Board Configuration" submenu is accessed, from the drop-down menu "Hardware Configuration", by clicking on the icon:

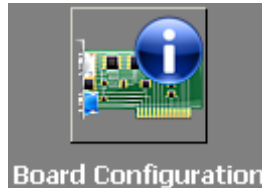

"Board Configuration" submenu enables the definition of fader settings, audio inputs/outputs modules and GPIOs of the mixing console.

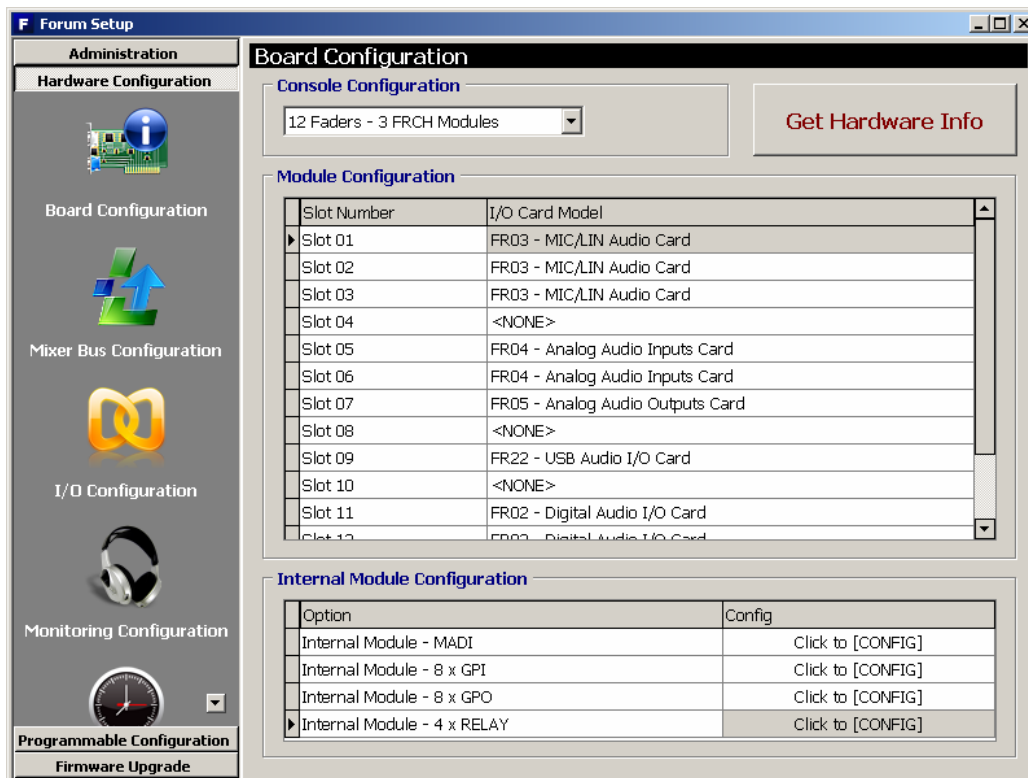

From left to right and from top to bottom the available options are:

- **"Console Configuration"**: here you can set the number of 4 faders modules (FRCH) that are installed in the FR01 chassis of **AEQ FORUM / GRAND FORUM**:
  - **1 FRCH module** corresponds to **4 faders** in the control surface. The remaining space should be filled with 2 FR20 blank modules.
  - **2 FRCH modules** correspond to **8 faders**. The remaining space should be filled with a FR20 blank module.
  - **3 FRCH modules** correspond to **12 faders**.
  - **4 FRCH modules** correspond to **16 faders**. The remaining space should be filled with a FR20 blank module. This configuration is available only for GRAND FORUM.
  - **5 FRCH modules** correspond to **20 faders**. This configuration is available only for GRAND FORUM.

- **“Get Hardware Info”**: allows you to load automatically in the application the configuration of hardware modules integrated into the console. By clicking on this option, the ForumSetup software communicates with the AEQ FORUM mixing console (therefore, there should be connection between the computer where is running the configuration software and one of the network ports of the mixing console) and retrieves the hardware configuration as installed in your system.

**IMPORTANT NOTE:** when there is a configuration loaded yet in the application, this option overwrites that configuration, changing the name of logical lines, routing... That’s why you will be asked for a confirmation:

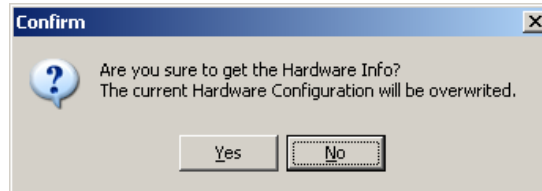

Therefore, we recommend you to previously save the loaded configuration by means of **“Export”** option (see section 4.1.1) and, when a new configuration is being prepared, to use this hardware synchronization option as first step of the process, before configuring any other parameter.

- **“Module Configuration”**: it shows the audio inputs and outputs modules of the 14 different slots available on the rear panel of AEQ FORUM. This option also allows you to configure manually (as opposed to the automatic option “Get Hardware Info”) the type of module placed in each slot.
- **“Internal Module Configuration”**: allows you to configure the general purpose inputs and outputs GPIO (both the physical contact relays and the opto-coupled) that are available on the rear panel in the section of common inputs and outputs of the AEQ FORUM. It also allows you to configure the operation of the optional multi-channel AES10 MAD1 communications module (available by means of user license: see section 4.1.1 of this manual).

#### 4.2.1.1. “Module Configuration” section.

“Module Configuration” section of “Board Configuration” submenu shows you a list of the audio inputs and outputs modules of the 14 different slots available on the rear panel of AEQ FORUM. This option also lets you configure manually (as opposed to the automatic option “Get Hardware Info”) the type of module placed in each slot.

The fields in this list are:

- **“Slot number”**: identifies the physical position of this module on the 14 slots rear panel of AEQ FORUM.
- **“I/O Card Model”**: type of configured audio inputs/outputs module. Each one of these 14 positions corresponds to the 14 physical slots at the rear panel of the console and can be configured as follows:
  - **<NONE>**: no module inserted or detected.
  - **FR02 - Digital Audio I/O Card.**
  - **FR03 - MIC/LIN Audio Card.**

**IMPORTANT NOTE:** only slots 1 to 4 can be used for this type of module. When you try to configure it in another slot an error message appears:

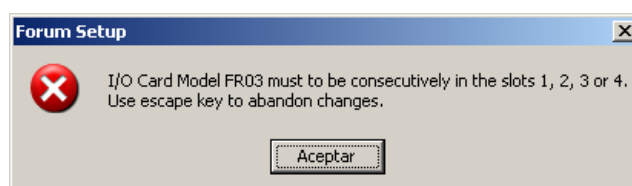

- **FR04 - Analog Audio Inputs Card.**
- **FR05 - Analog Audio Outputs Card.**
- **FR22 - USB Audio I/O Card.**
- **FR33 - Hybrid Audio Card.**

**IMPORTANT NOTE:** AEQ FORUM supports up to two FR33 modules per console; when you try to configure more than 2 modules, an error message appears:

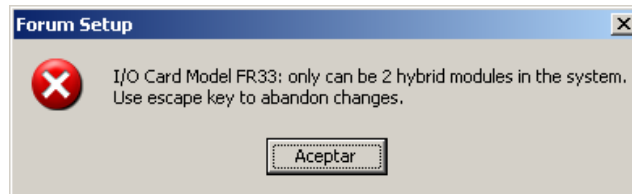

For more information about each of these audio inputs and outputs modules, please refer to section “**2.2.3. Audio inputs/outputs modules**” of this manual.

#### 4.2.1.2. “Internal Module Configuration” section.

“Internal Module Configuration” section of “Board Configuration” submenu allows you to configure the general purpose inputs and outputs GPIO (both the physical contact relays and the opto-coupled) that are available on the rear panel in the section of common inputs and outputs of the AEQ FORUM (please refer to section 2.2.2.1 of this manual). It also allows to configure the operation of the optional multi-channel AES10 MADI communications module (please refer to section 2.2.2.7 of this manual; **NOTE:** this module is available only by means of user license).

There are four distinct areas in this section:

1. **MADI:** is an optional communication module within the system common I/O section (available by means of user license: see section 4.1.1 of this manual). This is a bi-directional fiber-optic multi-channel audio link. The physical interface is a transceiver and the implemented standard is AES10-2003. The advanced configuration menu of this optional module is accessed by clicking “**Click to [CONFIG]**” and then clicking again on the “**CONFIG**” button that will appear. The configuration options are:
  - “**Disable/Enabled**”: deactivates or activates the module.
  - “**Channels**”: allows you to select the number of channels to be used: 56 mono channels in normal MADI mode or 64 channels in extended MADI mode.
  - “**Sync**”: indicates if the MADI interface will be master or slave for purposes of synchronization.
  - “**Used**”: allows you to configure how many of the 56 or 64 mono channels available are actually in use.

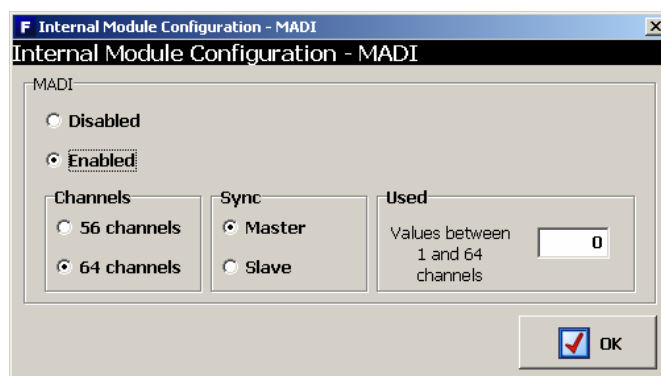

2. **GPI:** General Purpose Inputs. AEQ FORUM incorporates 8 opto-coupled GPI's on open-collector transistors.

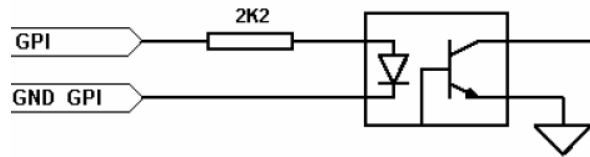

The advanced configuration menu of GPIs is accessed by clicking “Click to [CONFIG]” and then clicking again on the “CONFIG” button that will appear. The configuration options are:

- Edit the "Label" to identify the assigned role.
- Configure the working mode (“Level” column) of each GPI. The options are:
  - “High”: GPI activated on high level.
  - “Low”: GPI activated on low level.
  - “On Change”: GPI activated by transitions from high to low or the inverse.
  - “TH02”: GPI to accept the particular signalling that is generated by the AEQ TH-02EX MkII digital hybrid, as well as to enable the remote control of this particular equipment.

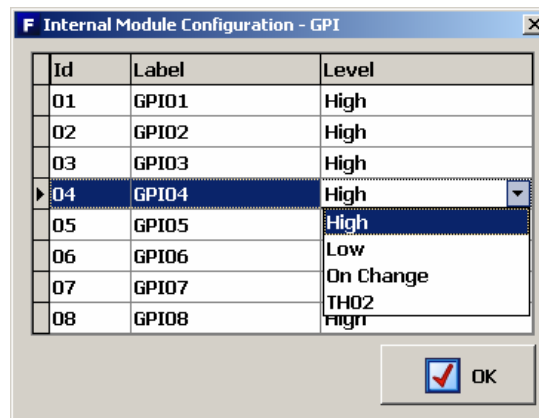

3. **GPO:** General Purpose Outputs. AEQ FORUM incorporates 8 opto-coupled GPO's on open collector transistors.

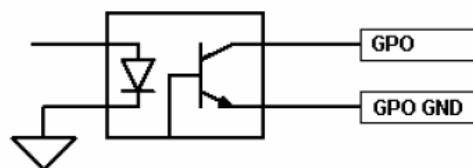

The advanced configuration menu of GPOs is accessed by clicking “Click to [CONFIG]” and then clicking again on the “CONFIG” button that will appear. The configuration options are:

- Edit the "Label" to identify the assigned role.
- Configure the working mode (“Level” column) of each GPO. The options are:
  - “Level High”: GPO activated on high level.
  - “Level Low”: GPO activated on low level.
  - “On Change”: GPO is activated by transitions from high to low or the inverse.
  - “Pulse High”: output in the form of a high level pulse with a duration that is defined in milliseconds in the field “Duration”.
  - “Pulse Low”: output in the form of a low level pulse with a duration that is defined in milliseconds in the field “Duration”.

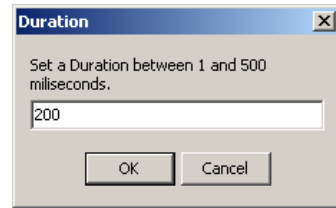
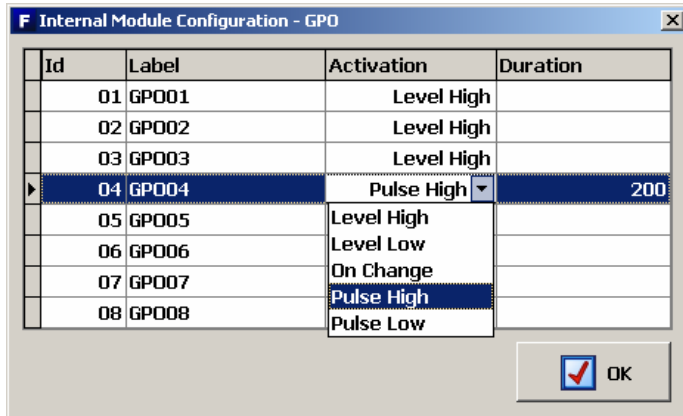

4. **RELAY:** allows you to configure the GPO outputs on physical contact relays as opposed to the opto-coupled GPO's on open collector transistors. There are four contact relays or contacts.

The advanced configuration menu of GPOs is accessed by clicking “**Click to [CONFIG]**” and then clicking again on the “**CONFIG**” button that will appear. This configuration menu is exactly like the previously detailed for GPOs.

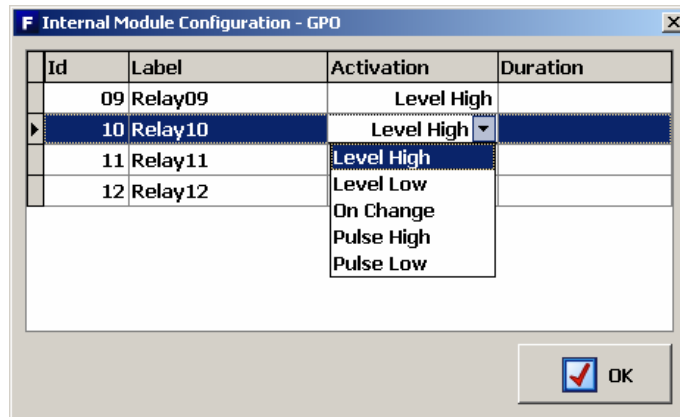

#### 4.2.2. “Mixer Bus Configuration” submenu.

“Mixer Bus Configuration” submenu is accessed, from the drop-down menu “Hardware Configuration”, by clicking on the icon:



“Mixer Bus Configuration” submenu allows you to define the configuration of the internal summing buses of the mixer. AEQ FORUM is supplied configured with the following factory default buses:

- “**Program**”: stereo and with working mode defined as “Program”.
- “**Audition**”: stereo and with working mode defined as “Audition”.
- “**Aux 1**”: stereo and with working mode defined as “Aux 1”.
- “**Aux 2**”: stereo and with working mode defined as “Aux 2”.
- “**Cue**”: PFL bus, stereo and with working mode defined as “Cue”.
- “**Studio**”: output bus toward studio monitors and headphones, stereo and with working mode defined as “Studio”.

- **“Control”**: output bus toward control monitors and headphones, stereo and with working mode defined as “Control”.
- **“MPX 1”**: mono and with working mode defined as “MPX 1”.
- **“MPX 2”**: mono and with working mode defined as “MPX 2”.
- **“MPX 3”**: mono and with working mode defined as “MPX 3”.
- **“MPX 4”**: mono and with working mode defined as “MPX 4”.
- **“MPX 5”**: mono and with working mode defined as “MPX 5”.
- **“MPX 6”**: mono and with working mode defined as “MPX 6”.
- **“MPX 7”**: mono and with working mode defined as “MPX 7”.
- **“MPX 8”**: mono and with working mode defined as “MPX 8”.

You can edit the "Label" for each mixer bus. If a mixer bus in factory configured as stereo is reconfigured to mono, the liberated channel will pop up on the configuration screen as available. The opposite would happen if you change the settings for an initially mono bus, “MPX 1” for instance: when you reconfigure it for stereo operation, the next bus line, “MPX 2” in this case, will disappear from the available buses on the configuration screen since this bus will be added to “MPX 1”.

You can define up to 32 mono or 16 stereo mixer buses, including the 7 predefined stereo buses and the 8 MPX mono buses as described above. The remainder of mixing buses can be defined as “Internal”.







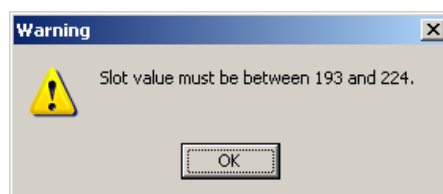





The mixer bus configuration table has the following fields:

- **“Slot”**: indicates the internal position of this signal in the digital audio bus of the mixer. The 32 available slots are numbered between 193 and 224 both inclusive. An error message will appear when you try to define a bus above those 32 available slots:



- **“Label”**: name of the bus. Maximum number of characters recommended is 6.
- **“Working Mode”**: is the description provided by the system regarding the functionality of each bus: Program, Audition, Aux 1, Aux 2, Cue, Studio, Control, MPX 1 to 8 or Internal.
- **“Stereo”**: allows you to configure the bus as a mono or stereo one.

The lower part of the “Mixer Bus Configuration” submenu includes a set of standardized buttons to manage the list of internal buses:

	Allows you to scroll to the top of the list.
	Allows you to move to the position immediately above in the list.
	Allows you to move to the position immediately below in the list.
	Allows you to scroll to the last position of the list.
	Allows you to insert a new entry in the list.
	Allows you to delete the selected entry from the list. Confirmation is requested.
	Allows you to edit the selected entry.
	Allows you to accept changes to the selected entry.
	Allows you to reject to the selected entry.
	Allows you to refresh the information shown in the list.

#### 4.2.3. “I/O Configuration” submenu.

“I/O Configuration” submenu is accessed, from the drop-down menu “Hardware Configuration”, by clicking on the icon:



This submenu allows you to configure the logical audio channels from the physical audio inputs and outputs modules and as previously defined in the “Board Configuration” submenu.

There are two distinct parts in this submenu; upper part of the screen is dedicated to the input channels configuration and the lower part of the screen is for the output channels configuration. In both parts of the screen the tables have the following fields:

- **“Id”**: indicates the equipment internal position of the signal.



- **“Label”**: alphanumeric name of the channel. Maximum number of characters recommended is 6. This is the name that appears in all displays and menus of the AEQ FORUM control surface.
- **“Model”**: type of the physical inputs/outputs module present in the rear panel of the unit. This field will be populated automatically once the “Board Configuration” has been accomplished (see section 4.2.1.1 of this manual).
- **“Config”**: access to advanced settings menu for the selected logical channel. To access, click on **“Click to [CONFIG]”** and then clicking again on the **“CONFIG”** button that will appear.

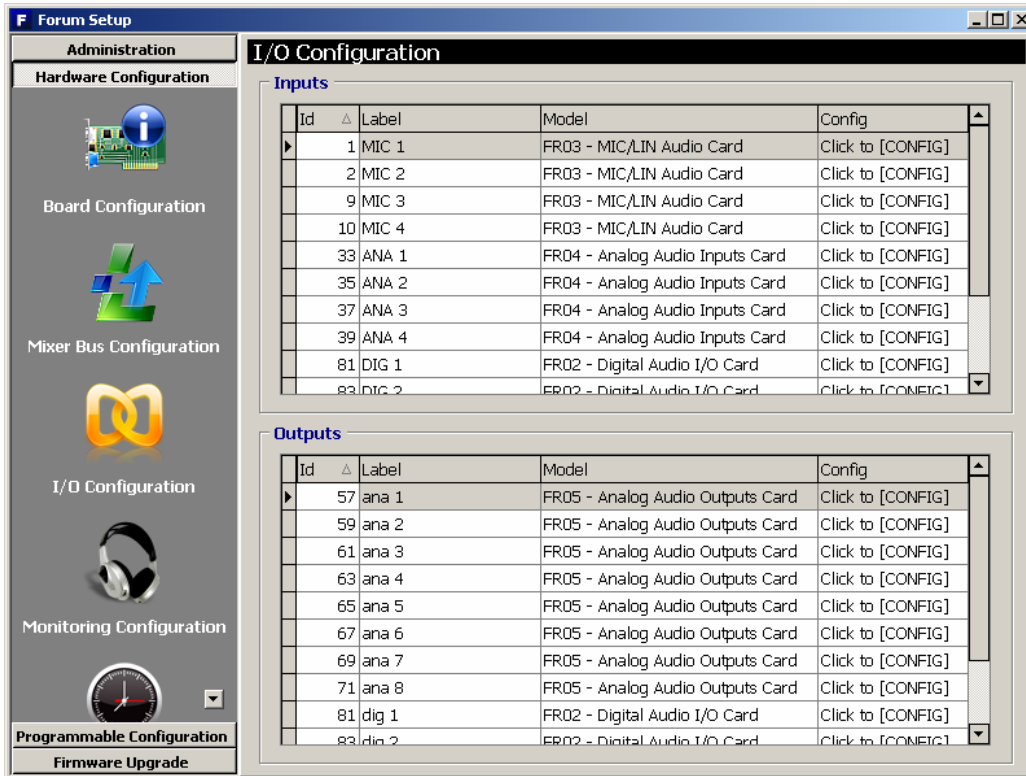

#### 4.2.3.1. Advanced configuration of input channels menu.

Even if all configuration options and possibilities are explained hereunder, it should be taken into account the on-screen options may vary depending on the inputs/outputs module that the logical audio audio channel has been configured for:

- **Headers**: indicates the type and position of the module that is configured at that moment.
  - **“FRzz Input configuration”** means that we are setting the input of a FR"zz" type card.
  - **“INPUT HW:xx.0y”** means that we are setting the input "y" of the card located in slot xx.
- **“Label”**: alphanumeric name of the channel. Maximum number of characters recommended is 6. This is the name that appears on all displays and menus of the AEQ FORUM control surface.
- **“Fader Start”**: allows you to select a GPO (from the list defined in chapter 4.2.1.2) to perform the Fader-start function for this channel. “None” indicates there is no Fader-start function associated to that channel.

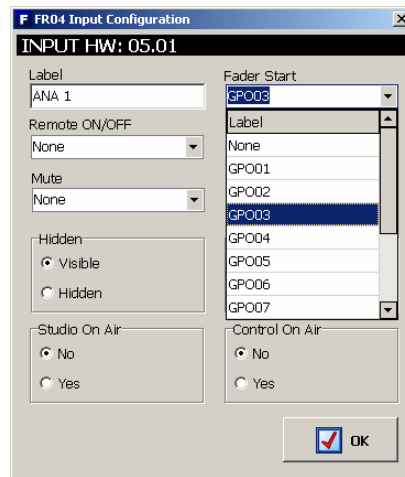

- **“Remote ON/OFF”**: allows you to select a GPI (from the list defined in chapter 4.2.1.2) to perform the remote start function for this channel (Channel ON/OFF keys on control surface: see paragraph 2.1.1.8 of this manual). “None” indicates there is no Remote ON/OFF function associated to that channel.

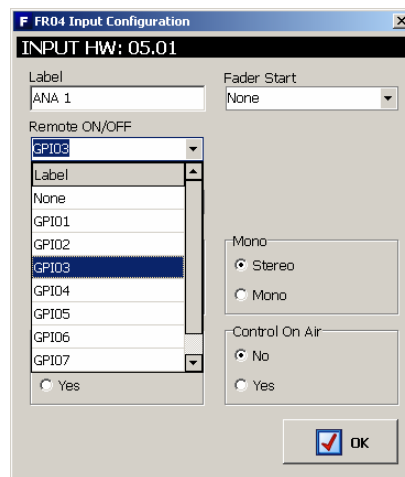

- **“Solo”**: allows you to select a GPI (from the list defined in chapter 4.2.1.2) to remotely cut the audio of all the microphone inputs that have been defined except the one that has been associated with the SOLO function”. This is useful when for example multiple microphones are used for the invited guests and the moderator needs to cut all the mics except his own. This option is only available for **microphone** channels and is typically used for the main microphone. You can not associate the same GPI to several channels. “None” indicates there is no SOLO function associated to that channel.

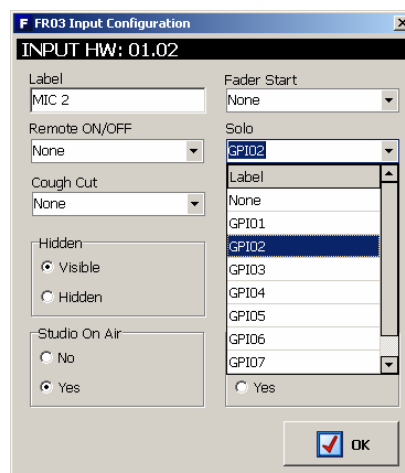

- **“Cough Cut”**: allows you to select a GPI (from the list defined in chapter 4.2.1.2) to perform the cough-cut function for this channel. This option is only available for **microphone** channels. “None” indicates there is no cough-cut function associated to that channel.
- **“Remote PFL”**: allows you to select a GPI (from the list defined in chapter 4.2.1.2) associated with the sending of the input channel to the CUE bus. This option is only available for **microphone** channels. You can not associate the same GPI to several channels. “None” indicates there is no Remote PFL function associated to that channel.
- **“Mute”**: allows you to select a GPI (from the list defined in chapter 4.2.1.2) associated with the function to mute the channel selected upon receiving a remote command. This option is **not** available for **microphone** channels. “None” indicates there is no Mute function associated to that channel.
- **“Hidden”**: allows you to select whether the selected input channel can be associated (“Visible”) or not (“Hidden”) to a channel from AEQ FORUM control surface through “FADER” menu (see section 3.4.3.1.3.1). An example of a typically “Hidden” signal would be the time TOPS.
- **“Mono”**: allows you to define whether the selected input channel is Mono or Stereo. By default, all the input channels (except the mic/line inputs corresponding to the modules FR03) of AEQ FORUM are defined as Stereo. If any channel is re-configured to Mono it will result in an incremented number of the listed available input channels: one Stereo Channel is converted into two Mono channels. This option is **not** available for **microphone** channels.
- **“Studio On Air”**: associates the activation of Channel ON/OFF keys of this channel with the triggering of a GPO for the “ON-AIR” lights of the Studio room (see section 4.2.4.1 of this manual). It also associates the studio monitors muting. Typically you would associate this function to microphone channels.
- **“Control On Air”**: associates the activation of Channel ON/OFF keys of this channel with the triggering of a GPO for the “ON-AIR” lights of the Control room (see section 4.2.4.1 of this manual). It also associates the muting of the control monitors and the CUE bus. Typically you would associate this function to auto-control microphone channel.

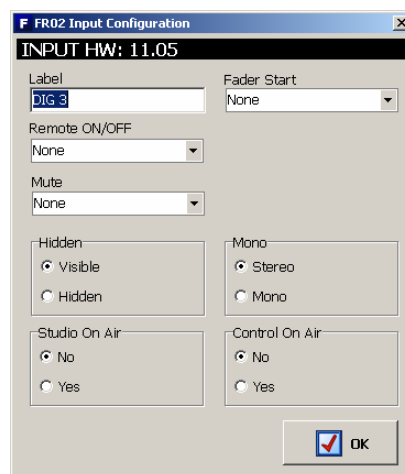

#### 4.2.3.2. Advanced configuration of output channels menu.

Even if all configuration options and possibilities are explained hereunder, it should be taken into account that the on-screen options may vary depending on the inputs/outputs module that the logical audio channel has been configured for.

- **Header**: indicates the position of the module that is configured at that moment.
  - **“OUTPUT HW:xx.0y”** means that we are setting the output “y” of the card located in slot xx.

- **“Label”**: alphanumeric name of the channel. Maximum number of characters recommended is 6. This is the name that appears on all displays and menus of the AEQ FORUM control surface.
- **“Default Routing”**: allows you to configure the signal routed by default to that output channel. You can select any input channel (“Inputs” in “Type” column) or any of the internal summing buses (“Mixer” in “Type” column; see section 4.2.2 of this manual).
- **“Mono”**: allows you to configure the logical output channel as Mono or Stereo. By default, all the outputs channels of AEQ FORUM are defined as Stereo. If any channel is re-configured to Mono it will result in an incremented number of the listed available output channels: one Stereo Channel is converted into two Mono channels.

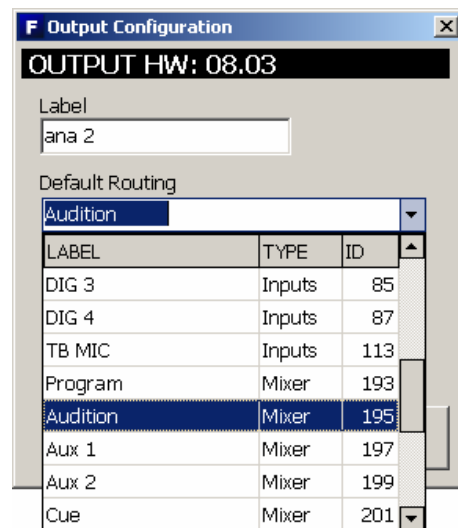
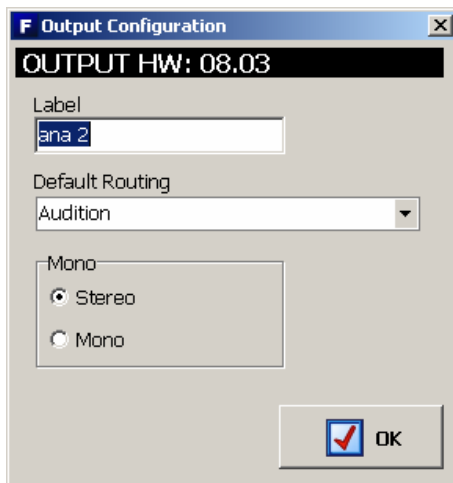

#### 4.2.4. “Monitoring Configuration “ submenu.

“Monitoring Configuration” submenu is accessed, from the drop-down menu “Hardware Configuration”, by clicking on the icon:



“Monitoring Configuration” submenu allows you to define the operation of the Control and Monitoring sections associated with the control room and the studio room. Please refer to sections 2.1.2.4 and 2.1.2.5 of this manual.



There are two distinct parts in this submenu: the upper part is dedicated to the configuration of the Studio Room section and the lower to the Control Room section.

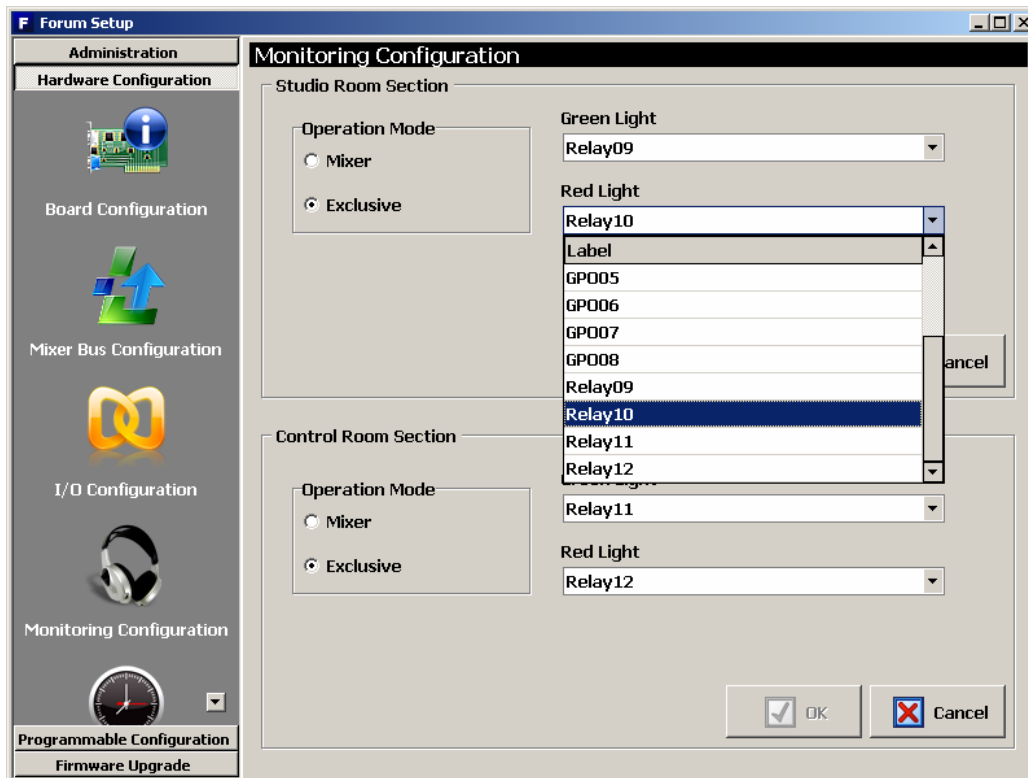

#### 4.2.4.1. “Studio Room Section”.

This section of “Monitoring Configuration” submenu lets you choose how the four keys under the display of the **Studio Room** Control and Monitoring section shall work, either in “**Mixer**” or “**Exclusive**”. If the option “Mixer” is selected, the output bus associated with “Studio” monitor and headphones will act as a summing bus and therefore may be more than one of the four keys simultaneously activated, thus mixing the signals corresponding to each of the four keys on the studio monitor and headphones. On the other hand, in the “Exclusive” mode, this output bus will not act as a summing bus and therefore may not be more than one key activated at any given time (this effectively means that by pressing any of the four keys, the previously activated one will be disconnected from the summing bus and replaced by the new selection).

In this section you can also allocate the GPO physical outputs associated with Studio “OFF AIR” green light (indicates that there are no sources, typically microphones, activated in the studio room) and “ON AIR” red light (indicates that there are no sources, typically microphones, activated in the studio room). You can choose between the opto-coupled GPO’s (1 to 8) or the contact relay GPO’s (9 to 12): these last ones are recommended. See section 2.2.2.1 of this manual.

#### 4.2.4.2. “Control Room Section”.

This section of “Monitoring Configuration” submenu lets you choose how the four keys under the display of the **Control Room** Control and Monitoring section shall work, either in “**Mixer**” or “**Exclusive**”. If the option “Mixer” is selected, the output bus associated with “Control” monitor and headphones will act as a summing bus and therefore may be more than one of the four keys simultaneously activated, thus mixing the signals corresponding to each of the four keys on the studio monitor and headphones. On the other hand, in the “Exclusive” mode, this output bus will not act as a summing bus and therefore may not be more than one key activated at any given time (this effectively means that by pressing any of the four keys, the previously activated one will be disconnected from the summing bus and replaced by the new selection).

In this section you can also allocate the GPO physical outputs associated with Control “OFF AIR” green light (indicates that there are no sources, typically microphones, activated in the control room) and “ON AIR” red light (indicates that there are no sources, typically microphones, activated in the control room). You can choose between the opto-coupled GPO’s (1 to 8) or the contact relay GPO’s (9 to 12): these last ones are recommended. See section 2.2.2.1 of this manual.

#### 4.2.5. “NTP Client Configuration” submenu.

“NTP Client Configuration” submenu is accessed, from the drop-down menu “Hardware Configuration”, by clicking on the icon:



“NTP Client Configuration” submenu allows you to enable synchronization of the date and time of the system using standard Ethernet NTP protocol, with the local AEQ FORUM clock slaved to the remote (NTP) signal.

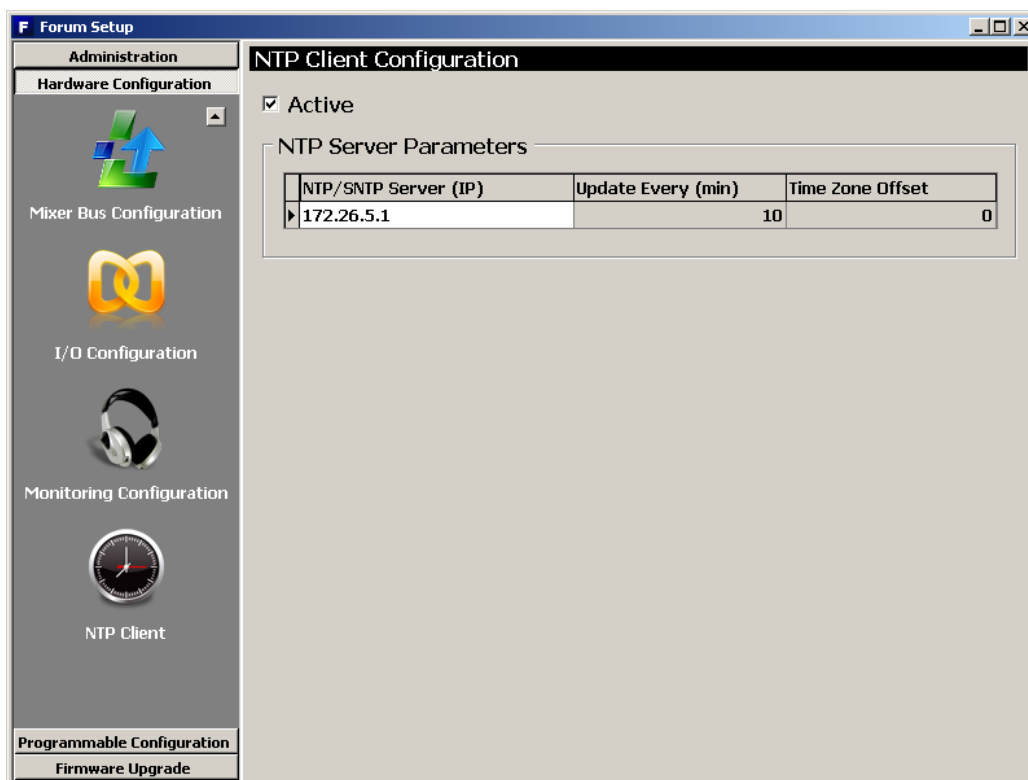

The on-screen options are:

- **“Active”**: allows you to activate or not this option.
- **“NTP/SNTP Server (IP)”**: IP address of the server with the remote master clock.
- **“Update Every (min)”**: refresh period, the frequency with which AEQ FORUM will contact the remote NTP time server to confirm that there are no deviations. The default value is set to 10 minutes.
- **“Time Zone Offset”**: allows you to compensate for the difference in time zone(s) between the location of the console and the time zone where the remote NTP clock is located.

### 4.3. “Programmable Configuration” menu.

This menu allows you to configure the internal routing of audio signals and the functions associated with the programmable keys, as well as define mics groups, create processes presets and manage the configuration memories (snapshots) of the unit. Clicking on the section “Programmable Configuration” on the main screen of the configuration software, a list of submenus is deployed on the left side of the workspace which include:

- **“Routing Configuration”**: allows you to define the cross points between input channels or internal summing buses and output channels or internal summing buses.
- **“Programmable Keys”**: allows you to configure the actions associated to each of the 15 programmable keys that are located in the Control and Monitoring section of AEQ FORUM.
- **“Mic Group Configuration”**: allows you to define microphone groups.
- **“Preset Configuration”**: allows you to create default settings associated with the various processing capabilities of AEQ FORUM: equalizers, filters, compressors/limiters and noise gates.
- **“Snapshot Configuration”**: allows you to manage the configuration memories stored in the unit.

**IMPORTANT NOTE:** In order to access to any of these submenus, it’s necessary to have a configuration loaded in the application (in case there’s no configuration, the message **“Empty configuration. Please read configuration before use”** is displayed). In order to have a configuration in the system, you have to either connect to AEQ FORUM console and read its configuration or load a configuration by means of “Import” option (see section 4.1.1 of this manual; you can find the “DemoConfiguration.FSC” file in C:\Program files \ForumSetup\Demos).

#### 4.3.1. “Routing Configuration” submenu.

“Routing Configuration” submenu is accessed, from the drop-down menu “Programmable Configuration”, by clicking on the icon:



“Routing Configuration” submenu allows you to define the cross-points between input channels or internal summing buses and output channels or internal summing buses. The entire set of cross-points available on the mixing console is arranged in a table with the following fields:

- **“Id Routing”**: internal numeric identifier for the input channel or the summing bus.
- **“Routing”**: “LABEL” of the input channel or summing bus. Please refer to sections 4.2.2 and 4.2.3 of this manual.
- **“Type”**: type of channel used in the cross-point: “Input” for input channels and “Mixer” for internal summing buses.
- **“Id Output”**: internal numeric identifier for the output channel.
- **“Output”**: “LABEL” of the output channel. Please refer to Section 4.2.3 of this manual.



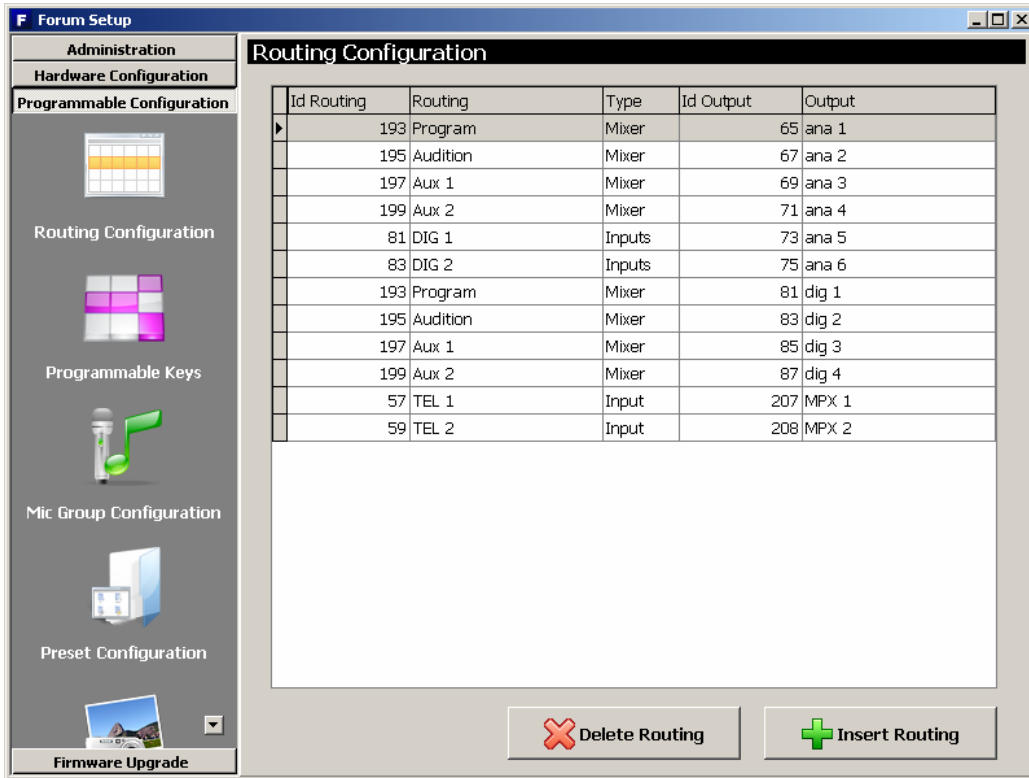

The bottom of the workspace in this submenu contains two options:

- **“Delete Routing”**: eliminates the selected cross-point. Confirmation is requested.

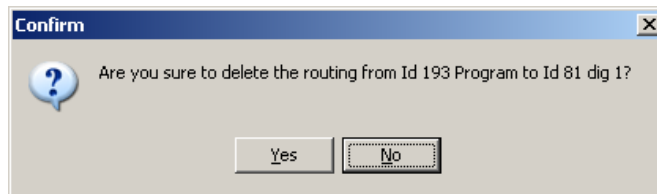

- **“Insert Routing”**: you can create a cross-point through a simple process that allows you to select an input channel or an internal summing bus as the source, and an output channel or an internal summing bus as the destination. These names or labels have been previously defined in the “I/O Configuration” submenu.

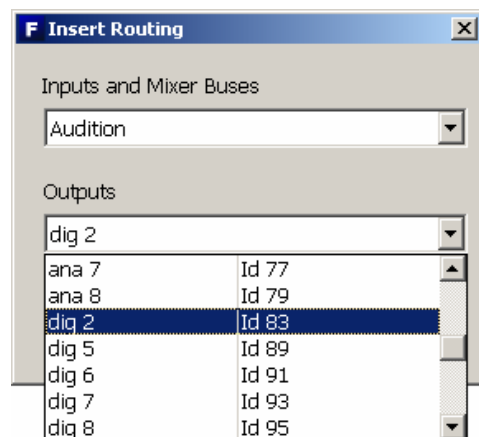
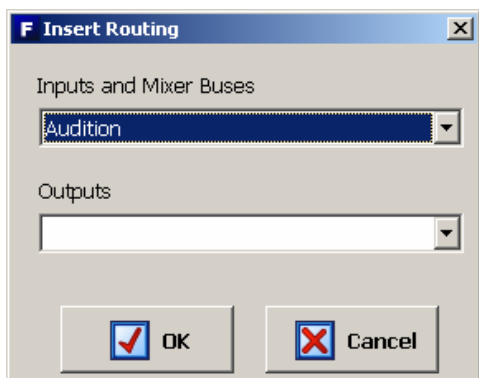

#### 4.3.2. “Programmable Keys” submenu.

“Programmable Keys” submenu is accessed, from the drop-down menu “Programmable Configuration”, by clicking on the icon:



“Programmable Keys” submenu lets you configure the actions associated with each of the 15 programmable keys found in the Control and Monitoring section of the AEQ FORUM control surface (please refer to Section 2.1.2.2 of this manual).

Within this submenu there are two distinct areas:

- **“Keyboard”**: it’s the upper part of the screen that allows for the basic configuration of the 15 programmable keys.
- **“Key Configuration”**: it’s the lower part of the screen where the specific configuration of each of the 15 programmable keys is accomplished.

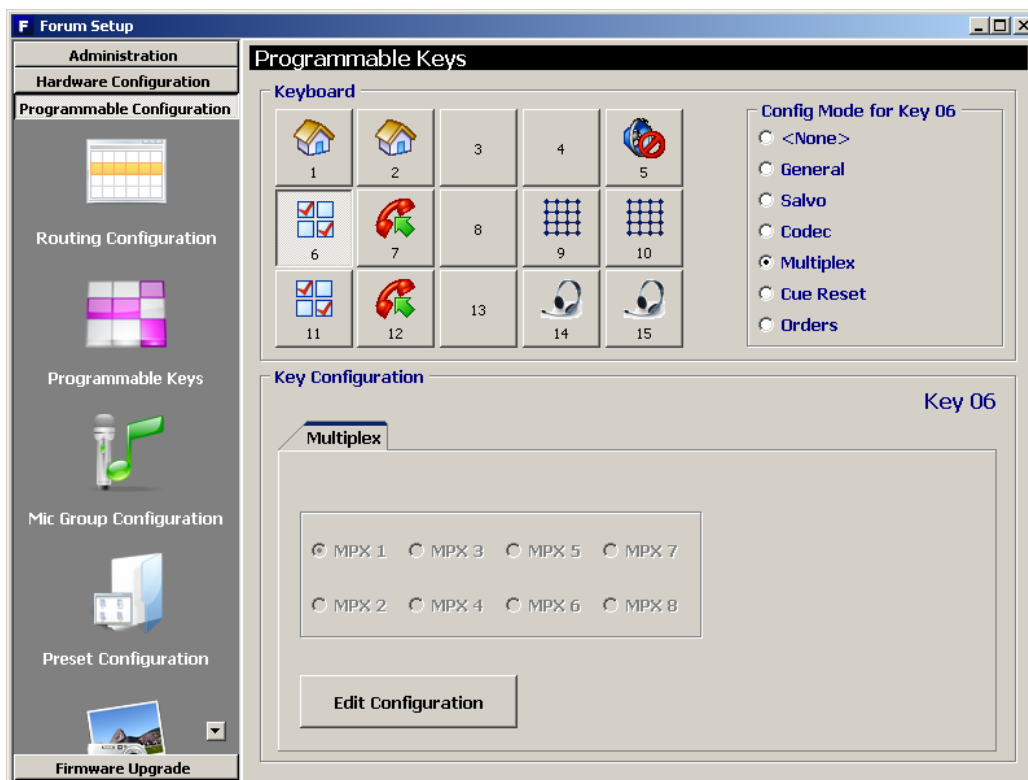

##### 4.3.2.1. Basic configuration of programmable keys.

This basic configuration section shows graphically the programmable keys corresponding to the Control and Monitoring section of the AEQ FORUM control surface. The programmable keys are numbered from 1 to 15 following the order from left to right and top to bottom.

To set a programmable key, simply click on it with the mouse and select from the list on the right to associate action. The available options are:

- **“None”**: no action associated.
- **“General”**: associated with activation of GPI and/or GPO.
- **“Salvo”**: allows you to configure activation/deactivation of a Salvo.
- **“Codec”**: associated with remote control of external communications equipment through GPIs and GPOs.
- **“Multiplex”**: allows you to make a quick management of signal routing toward a “MPX” type internal summing bus (these buses are typically used for sending to codecs, hybrids or other auxiliary destinations).
- **“Cue Reset”**: allows you to cancel all the signals sending to the CUE bus at that moment.
- **“Orders”**: allows you to send the orders microphone to the selected output channel.

#### 4.3.2.2. Configuration of “General” programmable keys.

Programmable keys that are set to “General” are used to activate GPIs and GPOs. A key set to this function is assigned with a dedicated icon.



The lower part of the “Programmable Keys” submenu will show the associated options for “General” type keys, when this configuration mode is selected:

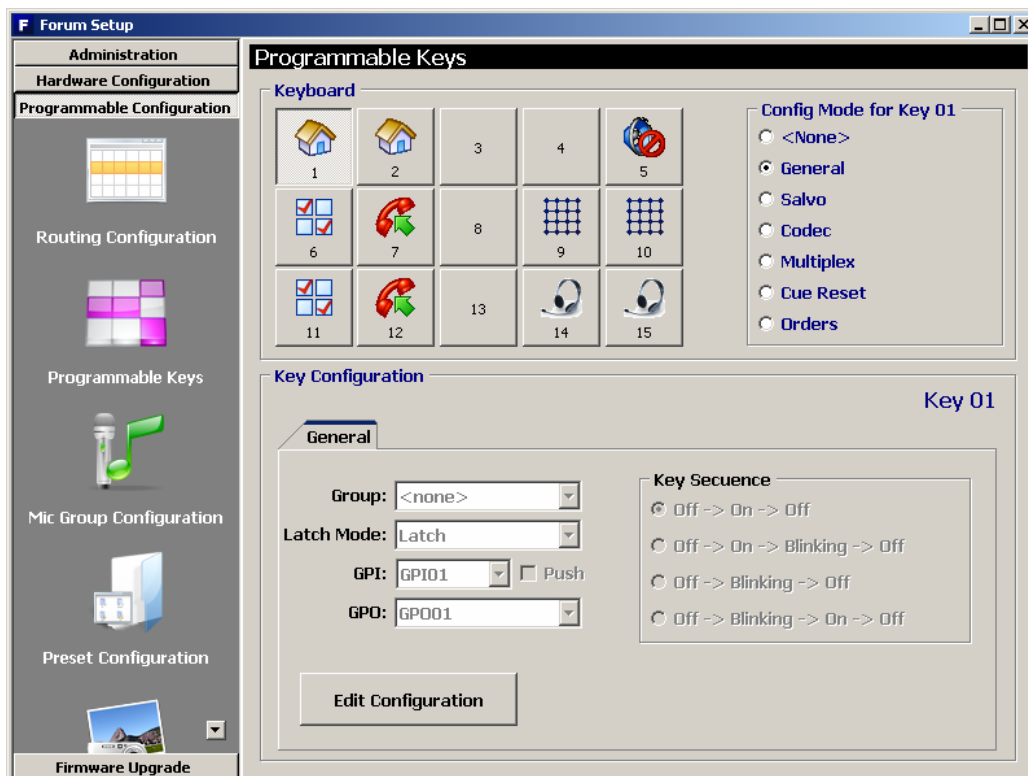

In order to be able to configure the programmable key (or edit a previously created configuration), you have to press the **“Edit Configuration”** button, to active and allows you to configure the following fields:

- **“Group”**: allows you to assign the programmable key to a group. Assign a key to a group when you need to define exclusive operation between various programmable keys (the activation of one of them entail the deactivation of the one active at that moment). You can create up to 8 programmable keys groups. “None” indicates that key is not assigned to a group.
- **“Latch Mode”**: allows you to configure the key as “Latch” or “Non Latch”, so after you press it, the key stays fixed or not. When a key is configured as “Non Latch”, it executes the associated function only while it remains pressed.
- **“GPI”**: allos you to select the physical GPI input, in the section of system common I/O's, associated to the programmable key activation.
- **“Push”**: when you associates a GPI and a GPO to the same key and you active this checkbox, the GPO is automatically activated when GPI is received. When “Push” checkbox is not active, this automatic activation is not made.
- **“GPO”**: allos you to select the physical GPO output, in the section of system common I/O's, associated to the programmable key activation.
- **“Key Secuence”**: allows you to select the operating sequence of the programmable key:
  - **“Off-On-Off”**: initially the key is off, it turns on when the programmable key is pressed and off when the key is pressed again. From this point the cycle is re-initiated.
  - **“Off-On-Blinking-Off”**: initially the key is off, it turns on when the programmable key is pressed, starts blinking when the key is pressed again and turn off when it's pressed again. From this point the cycle is re-initiated.
  - **“Off-Blinking-Off”**: initially the key is off, it starts blinking when the programmable key is pressed and off when the key is pressed again. From this point the cycle is re-initiated.
  - **“Off-Blinking-On-Off”**: initially the key is off, it starts blinking when the programmable key is pressed, turns on when the key is pressed again and turn off when it's pressed again. From this point the cycle is re-initiated.
- **“OK”**: allows you to accept the created or edited configuration.
- **“Cancel”**: allows you to reject the created or edited configuration. No change you may have made is saved.

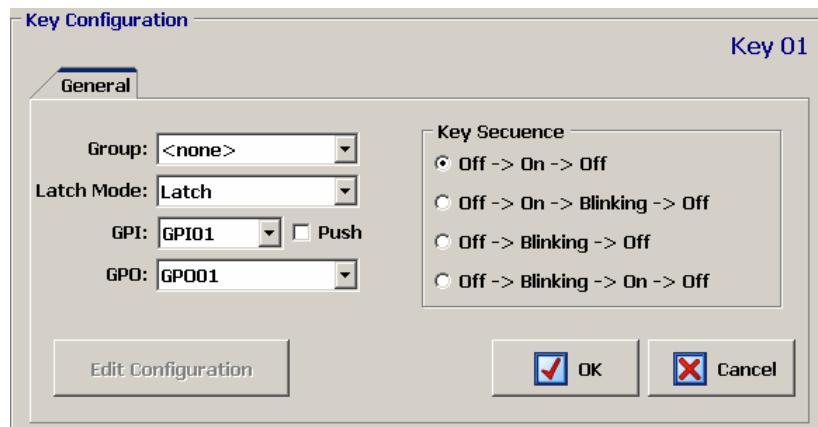

#### 4.3.2.3. Configuration of “Salvo” programmable keys.

Programmable keys that are set to “Salvo” are used to activate/deactive a Salvo or group of conecctions and/or disconnections of several cross-point. A key set to this function is assigned with a dedicated icon.

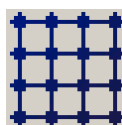

The lower part of the “Programmable Keys” submenu will allow you to configure the Salvo content.

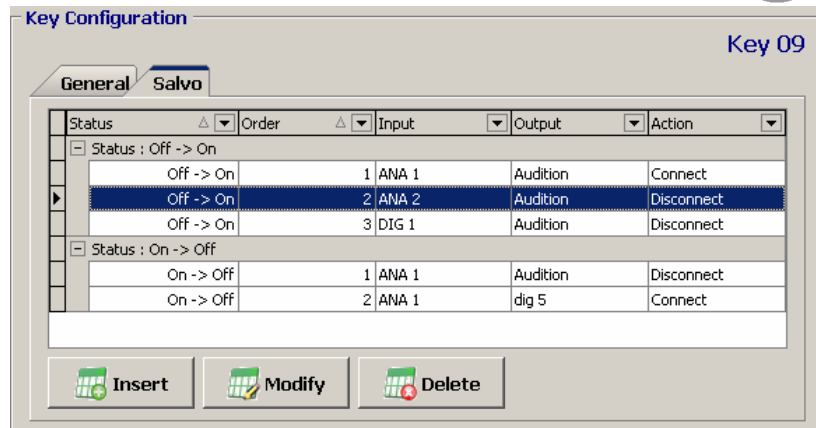

There are two tabs: “**General**” y “**Salvo**”.

The “**General**” tab gives you access to a screen identical to the one described in the previous section and allows you to configure the operational sequence of the programmable key and its relationship with the system GPI’s and GPO’s. This way it is possible to execute a Salvo by pressing the programmable key and activating at the same time a GPO or by the remote activation of the programmable key through GPI.

The “**Salvo**” tab includes specific functions, including a list of actions for each of the cross-points controlled by the Salvo and the order of execution (first-up, last-down). There are three buttons below the list enabling you to configure the list of actions:

- “**Insert**”: allows you to insert the activation or deactivation of a cross-point in the list of actions from a simple menu:
  - “**Status**”:
    - “**Off** → **On**”: the action is executed when the programmable key is activated.
    - “**On** → **Off**”: the action is executed when the programmable key is deactivated.
  - “**Order**”: allows you to set the position of this action in the general list of actions.
  - “**Input**”: allows you to select the input channel or internal summing bus.
  - “**Output**”: allows you to select the output channel or internal summing bus.
  - “**Action**”: allows you to select whether the cross-point between “Input” y “Output” is connected (“Connect”) or disconnected (“Disconnect”).

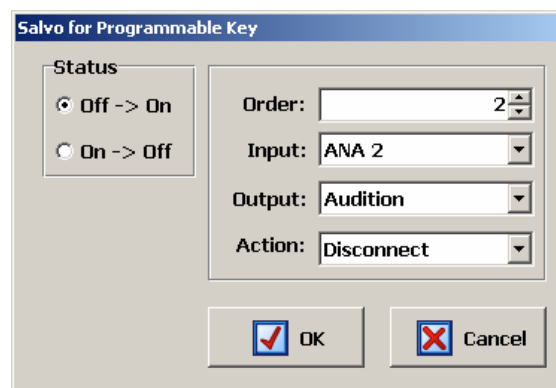

- “**Modify**”: allows you to modify a preconfigured action. The options on this screen are identical to those described for “Insert” option.
- “**Delete**”: allows you to delete a preconfigured action. Confirmation is requested.

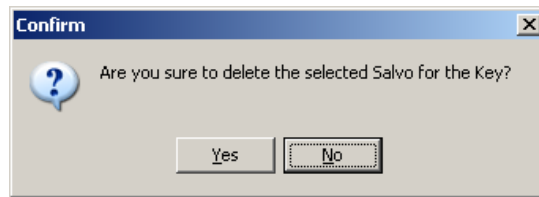

#### 4.3.2.4. Configuration of “Codec” programmable keys.

Programmable keys that are set to “Codec” enables you to assign functions associated with remote control of external communications equipment (such as audio-codecs) through associated GPIs and GPOs. A key set to this function is assigned with a dedicated icon.



The lower part of the “Programmable Keys” submenu will show the associated options for “Codec” type keys, when this configuration mode is selected.

In order to be able to configure the programmable key (or edit a previously created configuration), you have to press the “**Edit Configuration**” button, to active and allows you to configure the following fields:

- “**Device**”: it shows a list of pre-programmed devices in the “Codec” function. The available options are:
  - “**FR33**”: optional internal digital telephone hybrid module of AEQ FORUM. For more information see section 2.2.3.5 of this manual.
  - “**TH02**”: digital telephone hybrid AEQ TH02EX. For more information see [http://www.aeq.es/eng/pr\\_th02ex.htm](http://www.aeq.es/eng/pr_th02ex.htm).
  - “**Eagle**”: ISDN audio-codec AEQ EAGLE. For more information see [http://www.aeq.es/eng/pr\\_eagle.htm](http://www.aeq.es/eng/pr_eagle.htm).
  - “**Phoenix**”: IP/ISDN audio-codec AEQ PHOENIX STUDIO. For more information see [http://www.aeq.es/eng/pr\\_phoenixstudio.htm](http://www.aeq.es/eng/pr_phoenixstudio.htm).

Depending on the particular equipment selected, the following options may vary. For **FR33** module, the available options are:

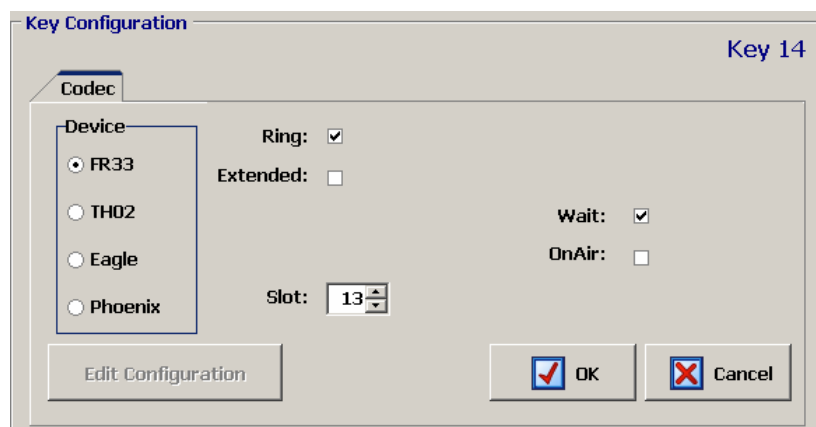

- “**Ring**”: the key starts to blink when there is an incoming call. This function can be combined in the same key with any of the following three functions.
- “**Extended**”: enables the option of frequency extender for the FR33 telephone hybrid. The key turns on when activated.

- **“Wait”**: allows you to put the call on hold (you can send audio to the telephone line, but the audio from the line is not received in the console). The key turns on when activated.
- **“OnAir”**: allows you to put the call on the air (you can send audio to the telephone line and the audio from the line is received in the console). The key turns on when activated.
- **“Slot”**: allows you to configure the position (between 1 and 14) on the rear panel of AEQ FORUM where FR33 module has been installed.
- **“OK”**: allows you to accept the created or edited configuration.
- **“Cancel”**: allows you to reject the created or edited configuration. No change you may have made is saved.
- **“OK”**: allows you to accept the created or edited configuration.
- **“Cancel”**: allows you to reject the created or edited configuration. No change you may have made is saved.

**IMPORTANT NOTE:** “Extended”, “Wait” and “OnAir” functions are exclusive between them (a programmable key can have only one of the three options associated), although any of them can be combined in the same key with “Ring” function.

For **TH02** hybrid, the available options are:

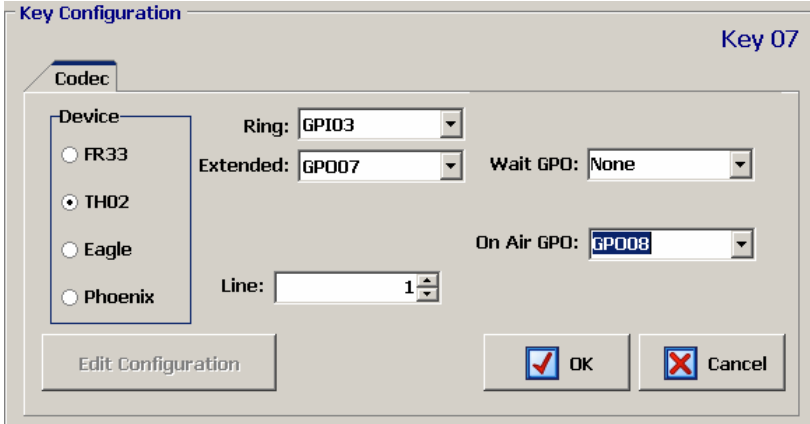

- **“Ring”**: allows you to select the GPI where the incoming call signal provided by the hybrid is wired. The key starts to blink when there is an incoming call. This function can be combined in the same key with any of the following three functions.
- **“Extended”**: enables the option of frequency extender for the TH02 telephone hybrid and select the GPO used to send the remote control signal to the hybrid. The key turns on when activated.
- **“Wait GPO”**: selects and configures the physical GPO output associated to “WAIT” function. The key turns on when activated and puts the call on hold (WAIT mode).
- **“On Air GPO”**: selects and configures the physical GPO output associated to “ON AIR” function. The key turns on when activated and puts the call on the air (ON AIR mode).
- **“Line”**: for dual line hybrids such as TH02, this identifies the integrated line 1 and line 2, to assign the different GPIs and GPOs for remote control
- **“OK”**: allows you to accept the created or edited configuration.
- **“Cancel”**: allows you to reject the created or edited configuration. No change you may have made is saved.

**IMPORTANT NOTE:** “Extended”, “Wait GPO” and “OnAir GPO” functions are exclusive between them (a programmable key can have only one of the three options associated), although any of them can be combined in the same key with “Ring” function.



For **Eagle** audio-codec, the available options are:

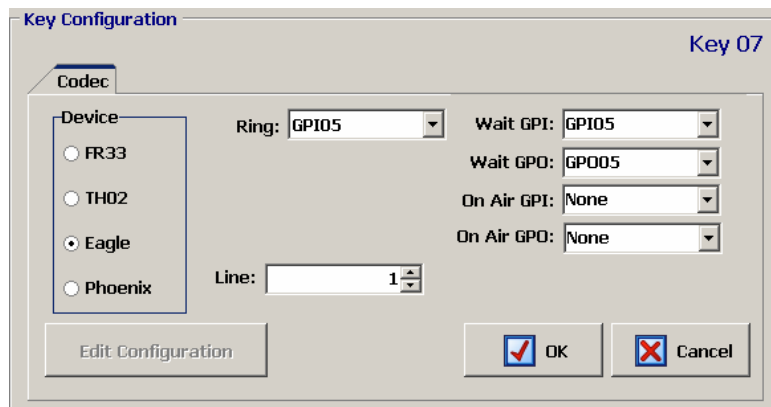

- **“Ring”**: allows you to select the GPI where the incoming call signal provided by the codec is wired. The key starts to blink when there is an incoming call. This function can be combined in the same key with any of the following four functions.
- **“Wait GPI”**: selects and configures the physical GPI input associated to “WAIT” function. The key turns on when WAIT mode (call on hold) is activated manually in the audio-codec.
- **“Wait GPO”**: selects and configures the physical GPO output associated to “WAIT” function. The key turns on when activated and puts the call on hold (WAIT mode).
- **“On Air GPI”**: selects and configures the physical GPI input associated to “ON AIR” function. The key turns on when ON AIR mode (call on the air) is activated manually in the audio-codec.
- **“On Air GPO”**: selects and configures the physical GPO output associated to “ON AIR” function. The key turns on when activated and puts the call on the air (ON AIR mode).
- **“Line”**: for dual line codecs such as Eagle and Phoenix Studio, this identifies the integrated line 1 and line 2, to assign the different GPIs and GPOs for remote control.
- **“OK”**: allows you to accept the created or edited configuration.
- **“Cancel”**: allows you to reject the created or edited configuration. No change you may have made is saved.

**IMPORTANT NOTE:** The pairs of functions “Wait GPI”-“Wait GPO” and “On Air GPI”-“On Air GPO” are exclusive between them (a programmable key can have only one of the two pairs associated).

For Codecs it is usual to program at least two programmable keys per channel: one to share “Ring”, “Wait GPI” and “Wait GPO” functions and another one to share “On Air GPI” and “On Air GPO” functions. The following screens show an example of programmable keys configuration for remote control of an AEQ EAGLE audio-codec.

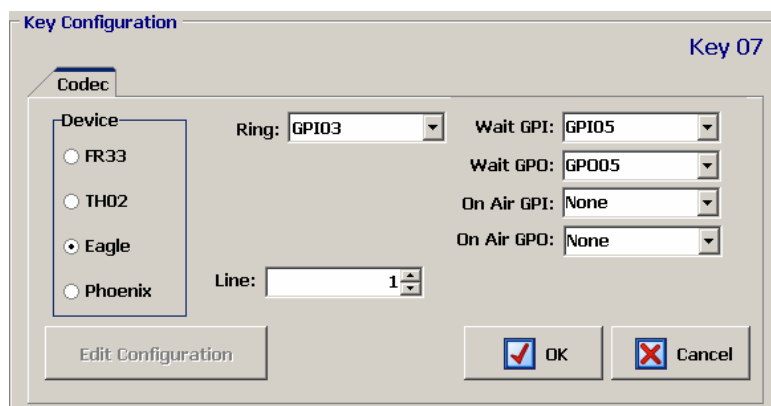

1

**Key Configuration** Key 08

Codec

Device

- FR33
- TH02
- Eagle
- Phoenix

Ring:

Wait GPI:

Wait GPO:

On Air GPI:

On Air GPO:

Line:

2

**Key Configuration** Key 09

Codec

Device

- FR33
- TH02
- Eagle
- Phoenix

Ring:

Wait GPI:

Wait GPO:

On Air GPI:

On Air GPO:

Line:

3

**Key Configuration** Key 10

Codec

Device

- FR33
- TH02
- Eagle
- Phoenix

Ring:

Wait GPI:

Wait GPO:

On Air GPI:

On Air GPO:

Line:

4

For **Phoenix Studio** audio-codec, the available options are:

**Key Configuration** Key 07

Codec

Device

- FR33
- TH02
- Eagle
- Phoenix

Ring:

Call GPO:

On Air GPO:

Line:

- **“Ring”**: allows you to select the GPI where the incoming call signal provided by the codec is wired. The key starts to blink when there is an incoming call. This function can be combined in the same key with any of the following four functions.
- **“Call GPO”**: selects and configures the physical GPO output associated to “CALL” function. The key turns on when activated and makes the call from the corresponding channel.
- **“On Air GPO”**: selects and configures the physical GPO output associated to “ON AIR” function. The key turns on when activated and puts the call on the air (ON AIR mode).
- **“Line”**: for dual line codecs such as Eagle and Phoenix Studio, this identifies the integrated line 1 and line 2, to assign the different GPIs and GPOs for remote control.
- **“OK”**: allows you to accept the created or edited configuration.
- **“Cancel”**: allows you to reject the created or edited configuration. No change you may have made is saved.

**IMPORTANT NOTE:** The functions “Call GPO” and “On Air GPO” are exclusive between them (a programmable key can have only one of the two functions associated).

#### 4.3.2.5. Configuration of “Multiplex” programmable keys.

Programmable keys that are set to “Multiplex” enables you to make a quick management of signal routing toward a “MPX” type internal summing bus (these buses are typically used for sending to codecs, hybrids or other auxiliary destinations). A key set to this function is assigned with a dedicated icon.

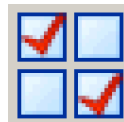

The lower part of the “Programmable Keys” submenu will show the associated options for “Multiplex” type keys, when this configuration mode is selected. In order to be able to configure the programmable key (or edit a previously created configuration), you have to press the **“Edit Configuration”** button, to active and allows you to assign to that key one of the 8 available “MPX” buses:

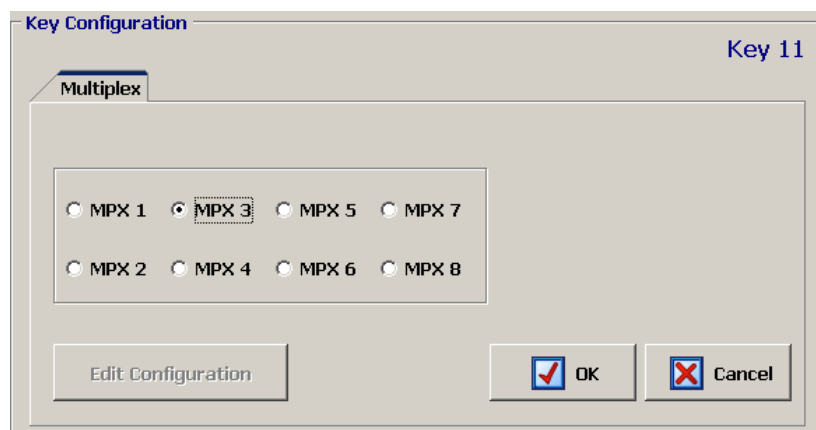

These keys works as follows: when you press and keep pressed the key you can activate the routing toward the associated “MPX” bus of any audio input channel assigned to a fader at that moment. To activate that routing, you just have to press the **“SELECT”** key of the desired channel/s (the associated LED turns on) while programmable key is pressed; by pressing again the “SELECT” key that routing is deactivated (the associated LED turns off). When you stop pressing the programmable key, the activated “SELECT” keys turns off and they recover its original function.

#### 4.3.2.6. Configuration of “Cue Reset” programmable key.

“Cue Reset” option allows you to configure a programmable key as a key to disconnect immediately all the signal sendings to the CUE bus at that moment. A key set to this function is assigned with a dedicated icon.



The lower part of the “Programmable Keys” submenu will show no options when this configuration mode is selected.

The activation of this “Cue Reset” function will have the following result in AEQ FORUM control surface: when the key is pressed, all the circuits or channels being sent to the CUE bus of the mixer will be disconnected and the LEDs of all the “CUE” keys that may be active will be turned off.

#### 4.3.2.7. Configuration of “Orders” programmable key.

Programmable keys that are set to “Orders” enables you to send the orders microphone to the selected output channel. A key set to this function is assigned with a dedicated icon.



The lower part of the “Programmable Keys” submenu will allow you to configure the output associated to the programmable key. In order to be able to configure the programmable key (or edit a previously configured key), you have to press the “**Edit Configuration**” button, to active and allows you to assign to that key any of the outputs defined in the system.

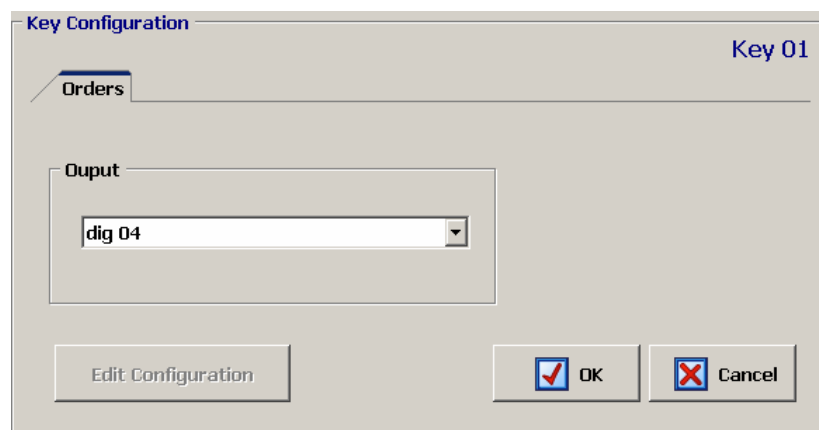

These keys works as follows: when you press and keep pressed the key you send to the selected output the orders microphone (any routing previously defined for that output is deactivated). When you stop pressing the programmable key, you stop sending the orders microphone and the previous routing is recovered.

### 4.3.3. “Mic Group Configuration” submenu.

“Mic Group Configuration” submenu is accessed, from the drop-down menu “Programmable Configuration”, by clicking on the icon:



“Mic Group Configuration” submenu allows you to define groups of microphones. Within this submenu there are two distinct areas on the screen:

- The left side shows the list of groups of microphones set up.
- The right side shows the list of the microphone inputs that are part of the group selected at that moment in the left part of the screen.

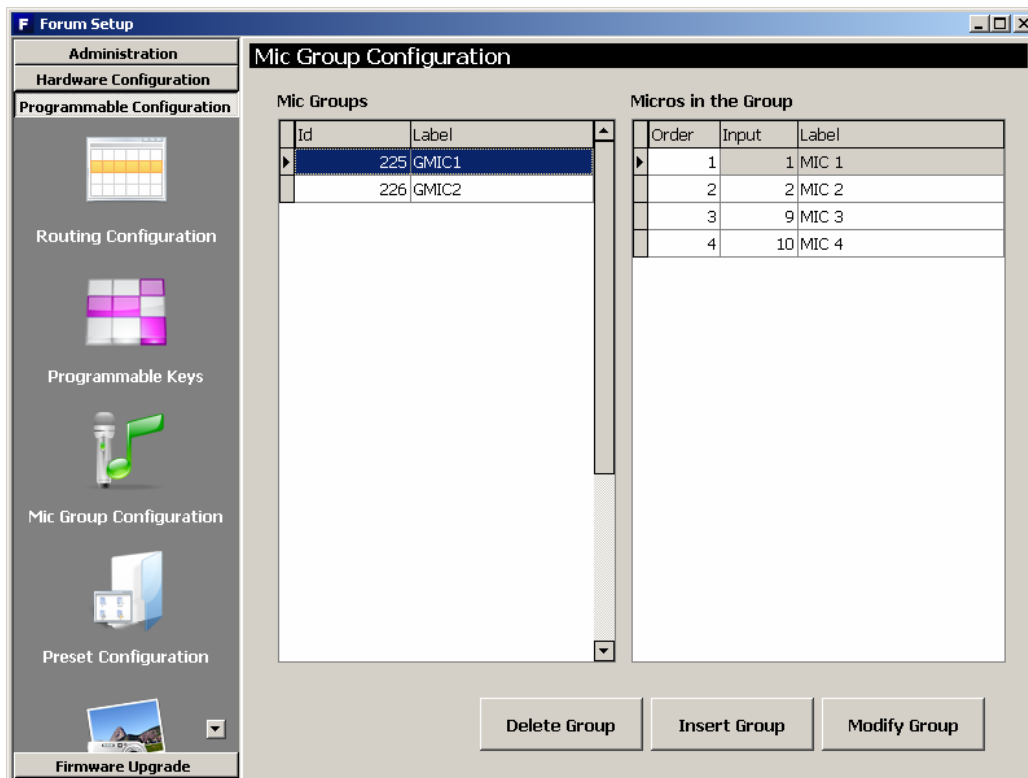



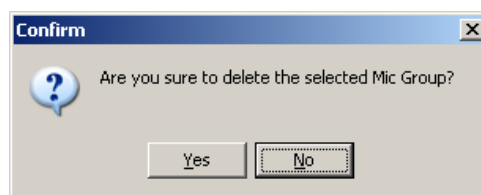

The three buttons at the bottom of the screen allow you to manage the list of groups of microphones and their individual configuration.

- **“Delete Group”**: deletes the selected group of microphones. Confirmation is requested.



- **“Insert Group”**: creates a new group of microphones and allows you to insert and set up the signals through the following menu options:

- **“Label”**: name or ID for the group of microphones. A maximum of 6 characters is recommended.
-  adds ALL microphones or audio inputs from the “Inputs availables” column to the “Inputs in the Group” column.
-  adds ONLY the microphone or audio input selected from the “Inputs availables” column to the “Inputs in the Group” column.
-  removes ONLY the microphone or audio input selected from the “Inputs in the Group” column back to the “Inputs availables” column.
-  removes ALL the microphones or audio inputs from the “Inputs in the Group” column back to the “Inputs availables” column.
- **“OK”**: allows you to accept the created or edited configuration.
- **“Cancel”**: allows you to reject the created or edited configuration. No change you may have made is saved.

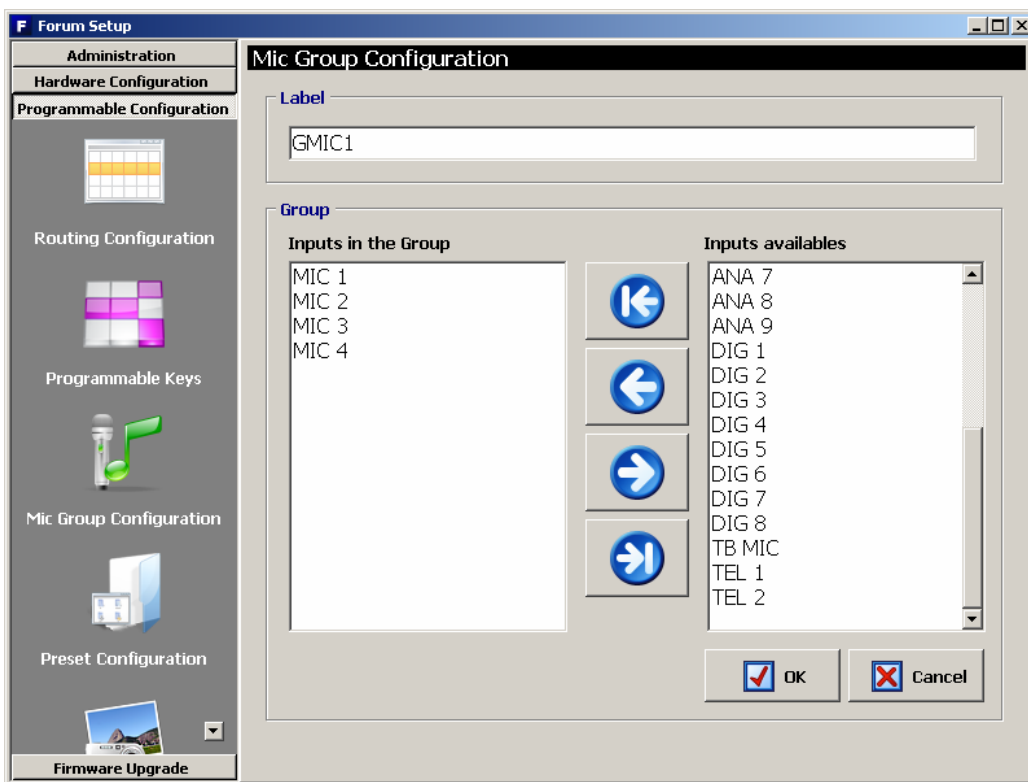

- **“Modify Group”**: allows you to modify the selected and previously created group of microphones. The menu is identical to previously described for “Insert Group” option.

#### 4.3.4. “Preset Configuration” submenu.

“Preset Configuration” submenu is accessed, from the drop-down menu “Programmable Configuration”, by clicking on the icon:







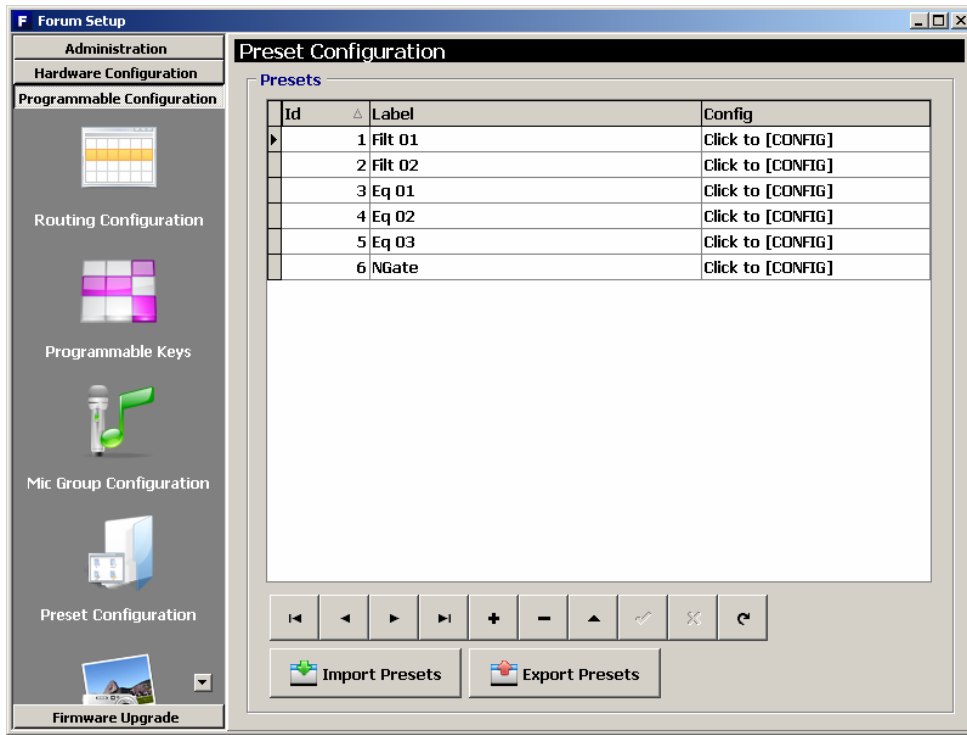





“Preset Configuration” submenu allows you to create default settings associated with the different audio processes available in AEQ FORUM: equalizers, filters, compressors/limiters and noise gates.

The main screen of this submenu is presented as a list of all the pre-sets created ordered by their “Id” and with a “Label” or name as identifier.



The lower part of the “Preset Configuration” submenu includes a set of standardized buttons to manage the list of presets:

-  Allows you to scroll to the top of the list.
-  Allows you to move to the position immediately above in the list.
-  Allows you to move to the position immediately below in the list.
-  Allows you to scroll to the last position of the list.
-  Allows you to insert a new entry in the list.
-  Allows you to delete the selected entry from the list. Confirmation is requested.
-  Allows you to edit the selected entry.
-  Allows you to accept changes to the selected entry.
-  Allows you to reject to the selected entry.
-  Allows you to refresh the information shown in the list.



The main screen of this submenu has also two buttons at the bottom:

- **“Import Presets”**: allows you to import to Forum Setup application all pre-sets stored on an AEQ FORUM mixing console that is connected through IP to the computer where the application is installed.
- **“Export Presets”**: allows you to export from Forum Setup application all stored pre-sets to an AEQ FORUM mixing console that is connected through IP to the computer where the application is installed.

The advanced configuration menu of each one of the stored pre-sets is accessed by clicking **“Click to [CONFIG]”** and then clicking again on the  button that will appear. The screen you access to looks as follows:

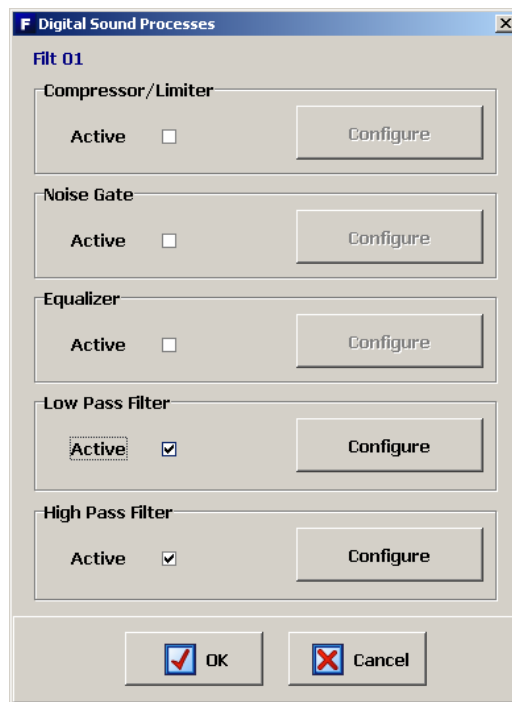

#### 4.3.4.1. Advanced configuration of Compressor/Limiter.

From the initial screen of the pre-sets advanced information menu (“Digital Sound Processes”) you can configure and activate/deactivate the Compressor/Limiter operation.

When you select the “Active” checkbox, the **“Configure”** button gets active and gives you access to the graphic display where the Compressor/Limiter associated parameters can be modified.

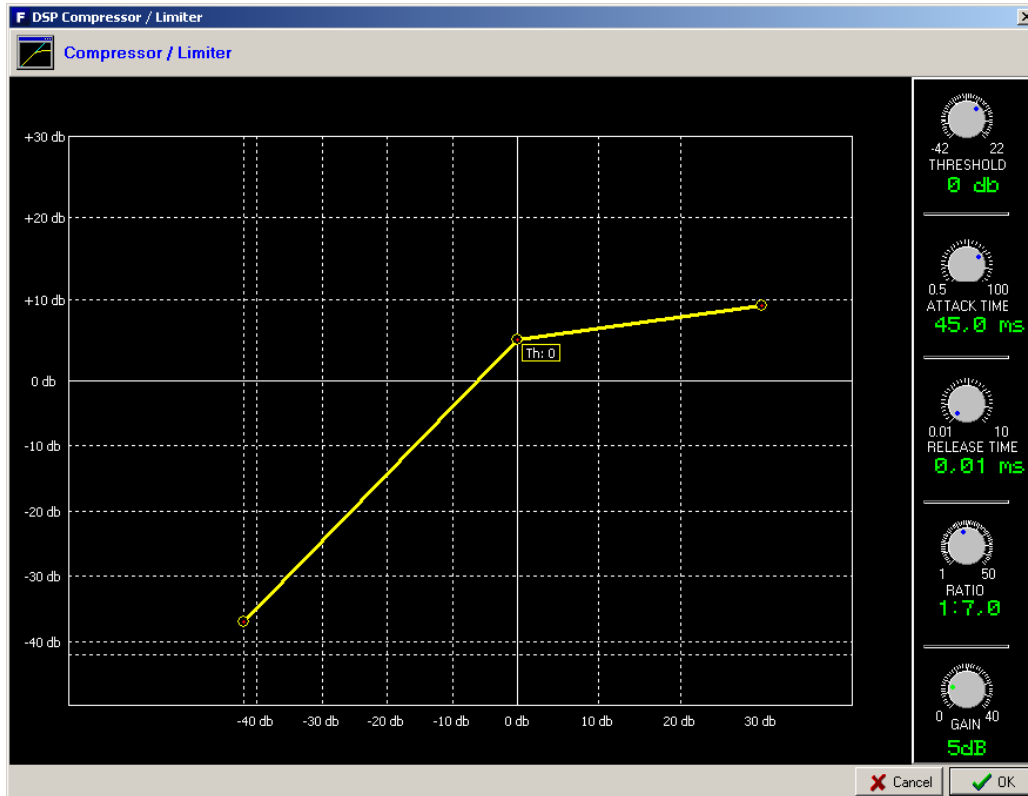

Dynamics processors are used to modify the dynamic ranges of an audio signal to adapt it to specific needs or to produce certain sound effects. A compressor enables you to reduce the dynamic range of the signal. Your purpose may be to adapt a signal with a very broad dynamic range to a circuit that will not support such wide variations in level, or to generate a certain sound in a signal.

The graph represents the variation produced in the different levels of the signal applied to this function. On the horizontal axis are the input levels, while the vertical axis shows output levels.

The “Compressor/Limiter” function acts as a “constant gain” compressor; that is, below the threshold, all input signals are amplified (or not amplified) equally, while above the threshold, the input levels are reduced to a greater or lesser degree according to the compression ratio.

If the compression range selected is the maximum, the function will act as a limiter in such a way that the signals that exceed the selected threshold at input will not exceed a certain level at output. For example, with a threshold = 0 dB, a gain of 10 dB and a compression ratio of 1:50, you will ensure that all the signals that exceed 10 dB at input will also be output at 10 dB, while the signals that are below the threshold will have an overall gain of 10 dB.

The available controls are:

- “THRESHOLD”: this is the threshold above which the compressor will act. Signal levels that exceed this threshold will be affected by the compressor settings. The threshold range varies from -42dB to +22dB.
- “ATTACK TIME”: this is the time it takes the compressor to react to an increase in the input signal. It ranges between 0.5 and 100 ms.
- “RELEASE TIME”: this is the maintenance time during which the compressor keeps acting, even when the level of the input signal has fallen below the threshold. It ranges between 0.01 and 10 s.
- “RATIO”: this is the compression ratio. A ratio of 1:1 does not involve any variation in the signal, as the level of the input signal is maintained at the output. A ratio of 2:1 indicates that the level of an input signal which exceeds the threshold will be reduced to half at the output. The highest ratio available is 50:1, which will be used to implement signal limiters. The limiter must reduce all signals exceeding a certain level to that level.

- “GAIN“: this enables you to apply a general gain to the signal. This entails a general increase of the signal level, which will be especially noted at low input levels that are under the threshold set. It ranges between 0 and 40dB.
- “OK“: allows you to accept the created or edited configuration. A double confirmation is required.
- “Cancel“: allows you to reject the created or edited configuration. No change you may have made is saved.

#### 4.3.4.2. Advanced configuration of Noise Gate.

From the initial screen of the pre-sets advanced information menu (“Digital Sound Processes”) you can configure and activate/deactivate the Noise Gate operation.

When you select the “Active” checkbox, the “**Configure**” button gets active and gives you access to the graphic display where the Noise Gate associated parameters can be modified.

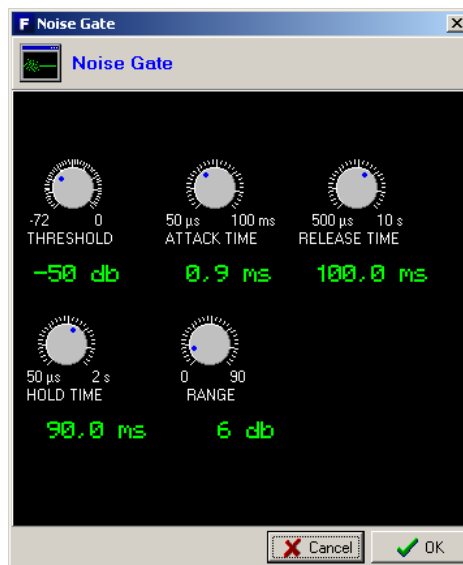

A noise gate is a dynamics processor that lets signals through whose level exceeds a certain threshold, strongly attenuating the signal levels below that threshold and thus muting noise. It enables its user to eliminate extraneous noise from a signal source, whether it is background noise in the studio, in the case of a microphone, or the background noise generated by a playback device, for example, a tape.

The available controls are:

- “THRESHOLD“: determines the level above which signal is allowed through the gate.
- “ATTACK TIME“: the time for the gate to react to a signal that is exceeding the threshold.
- “RELEASE TIME“: the time that the gate should remain open once the signal exceeding threshold has disappeared.
- “HOLD TIME“: the time that the gate should remain open when the signal falls below the threshold.
- “RANGE“: the limit of dynamic range where created configuration will have effect.

The threshold must be adjusted to a level slightly higher than the level of the noise to be avoided. Thus, the threshold will be set at a very low level. Above the threshold, the noise gate does not act (unity gain), letting the rest of the signal through without processing it. The gate remains closed; i.e. when the signal surpasses the threshold level, the gate opens. The attack time is the time the gate takes to open (unity gain) when it receives a signal whose amplitude exceeds the threshold level; this time must be short to avoid cutting off the beginning of a sentence or song. The release time is the time the gate takes to close when the signal level falls below the threshold. The hold time is the minimum time during which the gate remains open; it is used to prevent the gate from closing when the signal level drops briefly—for example, when an announcer pauses while speaking. The hold time prevents the gate from opening and closing constantly in the presence of a signal whose level fluctuates in a range close to the threshold level.

#### 4.3.4.3. Advanced configuration of Equalizer.

From the initial screen of the pre-sets advanced information menu (“Digital Sound Processes”) you can configure and activate/deactivate the Equalizer operation.

When you select the “Active” checkbox, the “**Configure**” button gets active and gives you access to the graphic display where the Equalizer associated parameters can be modified.

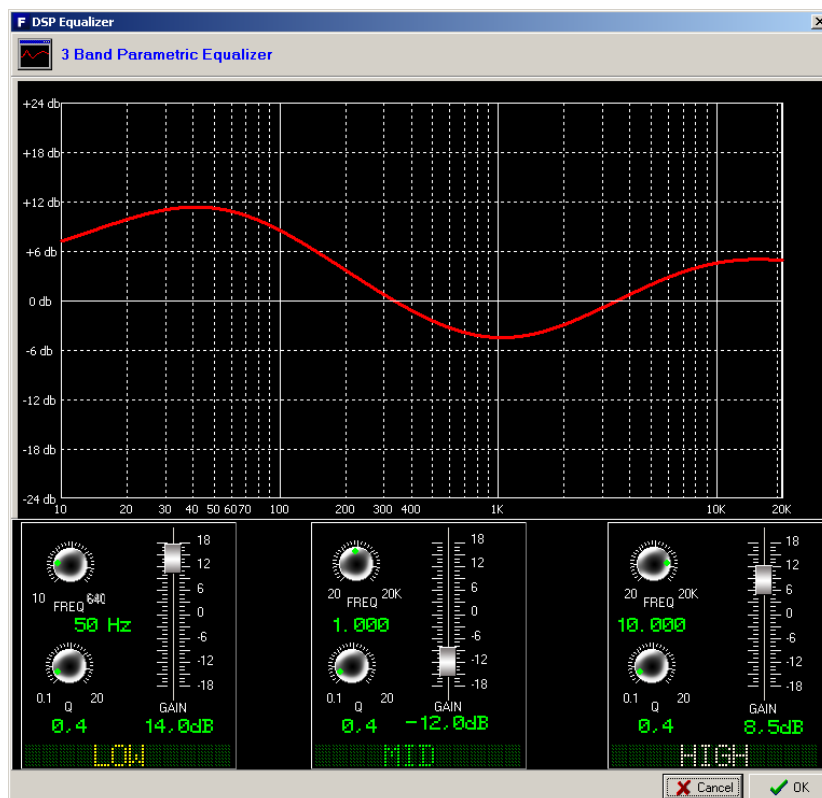

#### 4.3.4.4. Advanced configuration of Low Pass Filter.

From the initial screen of the pre-sets advanced information menu (“Digital Sound Processes”) you can configure and activate/deactivate the Low Pass Filter operation.

When you select the “Active” checkbox, the “**Configure**” button gets active and gives you access to the graphic display where the Low Pass Filter associated parameters can be modified.

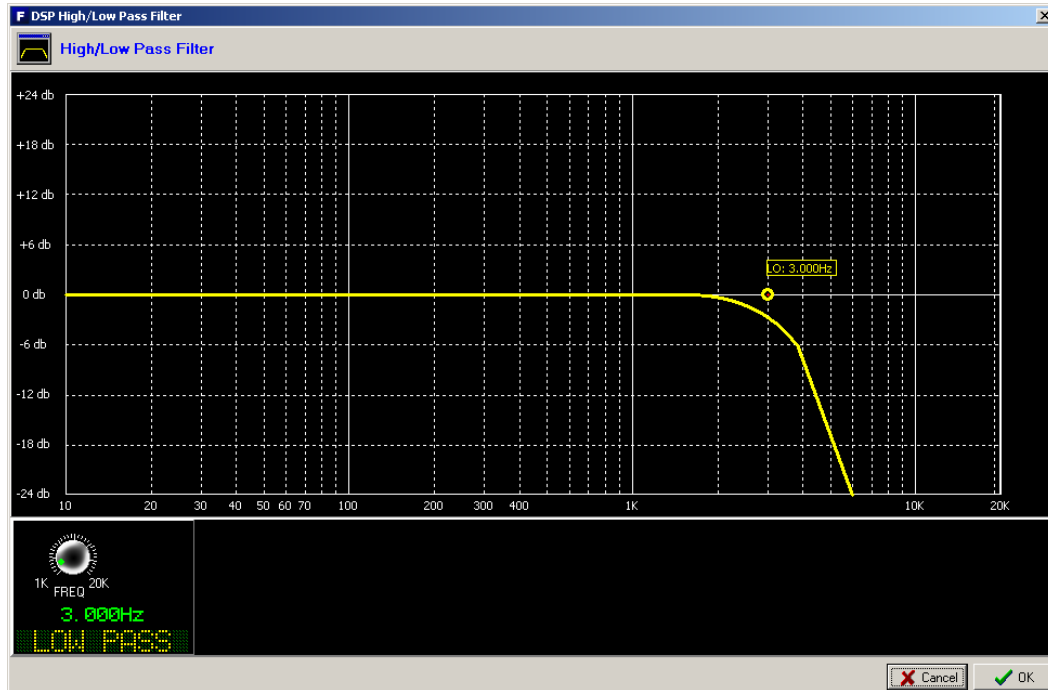

#### 4.3.4.5. Advanced configuration of High Pass Filter.

From the initial screen of the pre-sets advanced information menu (“Digital Sound Processes”) you can configure and activate/deactivate the High Pass Filter operation.

When you select the “Active” checkbox, the “**Configure**” button gets active and gives you access to the graphic display where the High Pass Filter associated parameters can be modified.

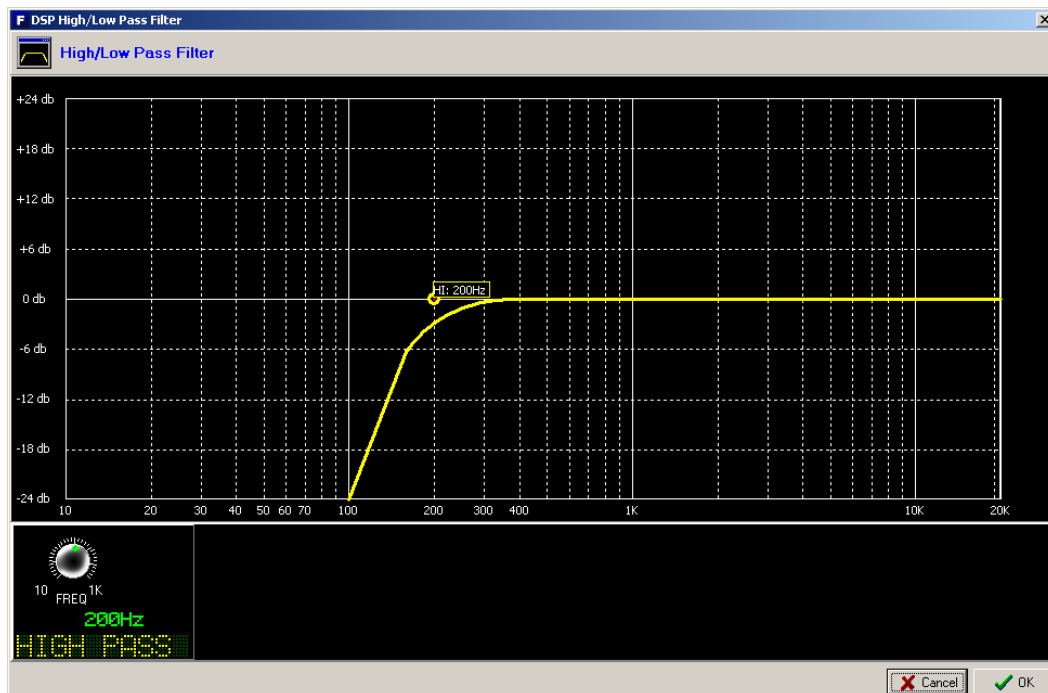

#### 4.3.5. “SnapShot Configuration” submenu.

“SnapShot Configuration” submenu is accessed, from the drop-down menu “Programmable Configuration”, by clicking on the icon:



“SnapShot Configuration” submenu allows you to manage the different configurations memories stored in AEQ FORUM and available to operators through the internal menu of the main screen of the Control and Monitoring section of the unit. Please refer to section 3.3 of this manual.

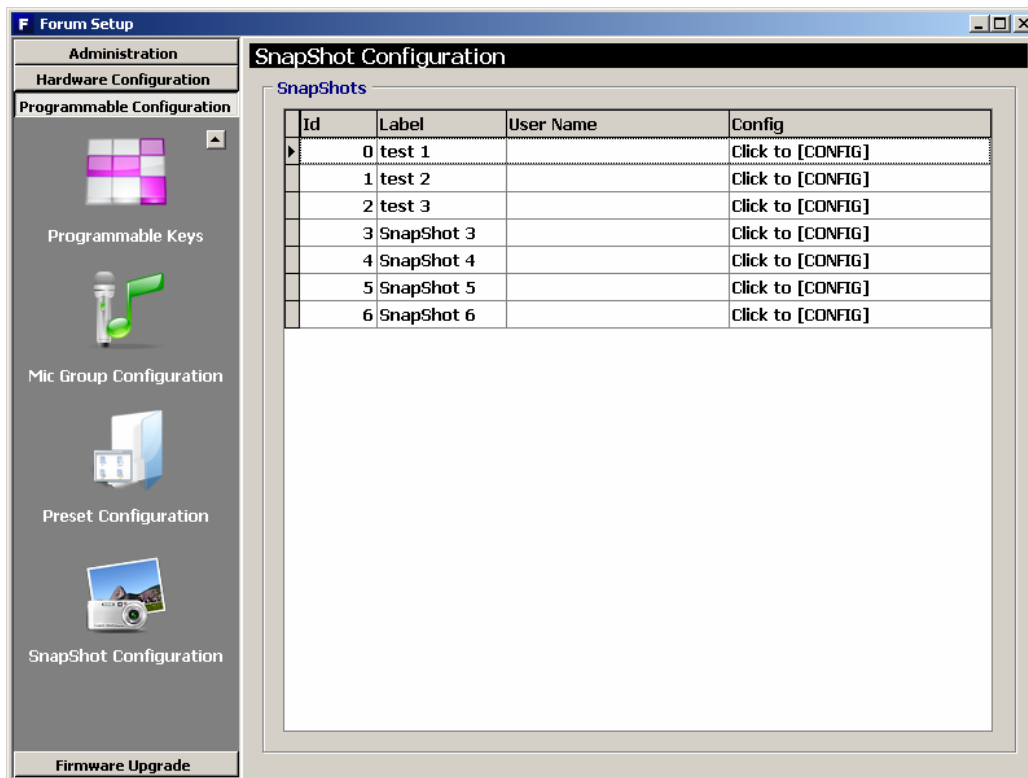

The main screen of this submenu is presented as a list of all the snapshots stored (there are up to 7 available snapshots), ordered by their “Id” and with a “Label” or name as identifier.

The advanced configuration menu of each one of the snapshots is accessed by clicking “**Click to [CONFIG]**” and then clicking again on the  button that will appear. The screen you access to looks as follows:

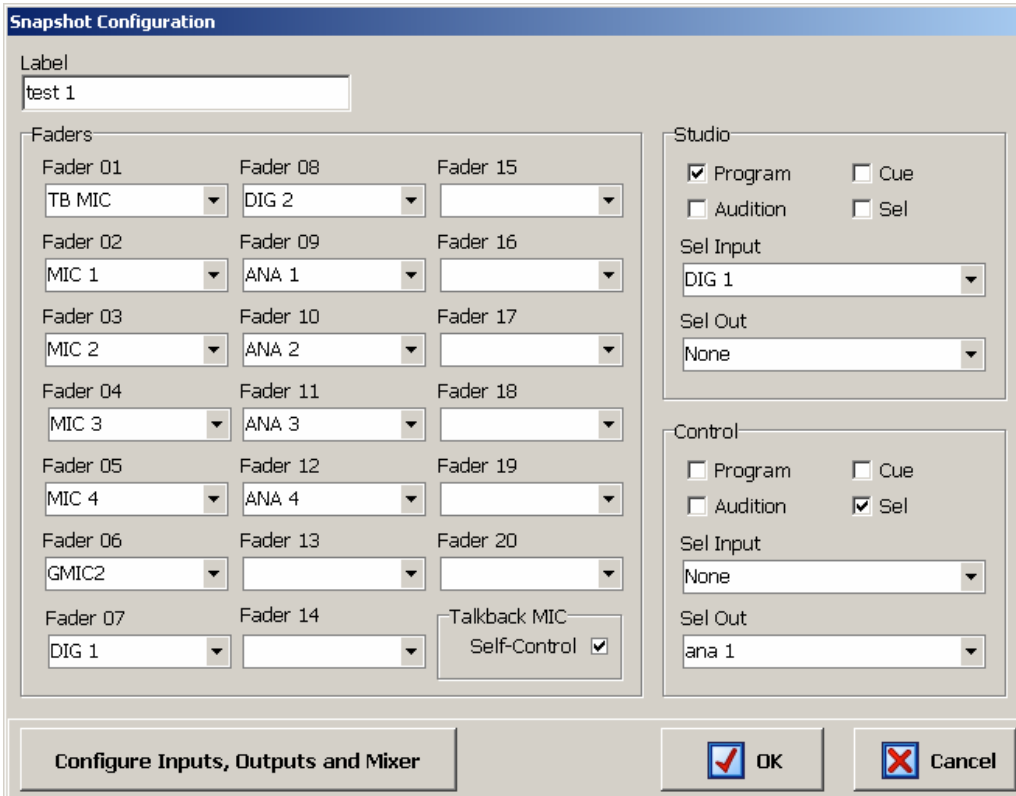

The available options in the snapshots advanced configuration menu, described from left to right and top to bottom, are:

- **“Label”**: alphanumeric label for the snapshot memory.
- **“Faders”**: 20 drop-down menus allow you to assign an input audio channel to each one of the physical faders of the control surface (up to 12 for AEQ FORUM and up to 20 for AEQ GRAND FORUM). The faders are numbered, from left to right, 1 through 20. The number of faders to configure depends on the number of 4 faders modules (FRCH) installed on the AEQ FORUM control surface (1, 2 or 3 FRCH modules can be installed, providing then with a maximum of 4, 8 or 12 channels) or AEQ GRAND FORUM control surface (4 or 5 FRCH modules can be installed, providing then with a maximum of 16 or 20 channels).
- **“Talkback MIC”**: allows you to configure the operation of the microphone input present in the common I/O’s section at the rear panel of the AEQ FORUM. When **“Self-Control”** checkbox is not activated, that input is configured only as an orders microphone toward studio or return for any open communication lines (this is a typical configuration for AEQ FORUM when installed in a Studio/Control configuration). When **“Self-Control”** checkbox is activated, that input is configured as autocontrol microphone (it simultaneously works as orders microphone), so the host of the radio program is also the operator of the mixing console (this is a typical configuration when the Studio and Control areas of the radio station are in the same room). Only when **“Self-Control”** checkbox is activated you can assign the talkback mic to a fader (when it’s not activated, the mic will not appear in the channels list).
- **“Studio”**: section where you can configure the initial activation of one or several keys to send signal to monitor and headphones placed under the display of the **studio** monitoring section. The available options are **“Program”**, **“Audition”**, **“Cue”** and **“Sel”** (when section is configured in **“Exclusive”** mode, you can activate only one key: see section 4.2.4.1 of this manual). **“Sel Input”** and **“Sel Out”** drop-down menus allows you to select a single input, output or internal summing bus to associate it initially with the **“SEL”** monitoring key (that selection can be modify later by means of **“HP/SOURCE”** encoder).



- **“Control”**: section where you can configure the initial activation of one or several keys to send signal to monitor and headphones placed under the display of the **control** monitoring section. The available options are “Program”, “Audition”, “Cue” and “Sel” (when section is configured in **“Exclusive”** mode, you can activate only one key: see section 4.2.4.1 of this manual). **“Sel Input”** and **“Sel Out”** drop-down menus allows you to select a single input, output or internal summing bus to associate it initially with the “SEL” monitoring key (that selection can be modify later by means of “HP/SOURCE” encoder).
- **“Configure Inputs, Outputs and Mixer”**: this button gives you a quick access to the advanced configuration section for audio inputs and outputs channels and internal mixer buses, presented in three consecutive columns.

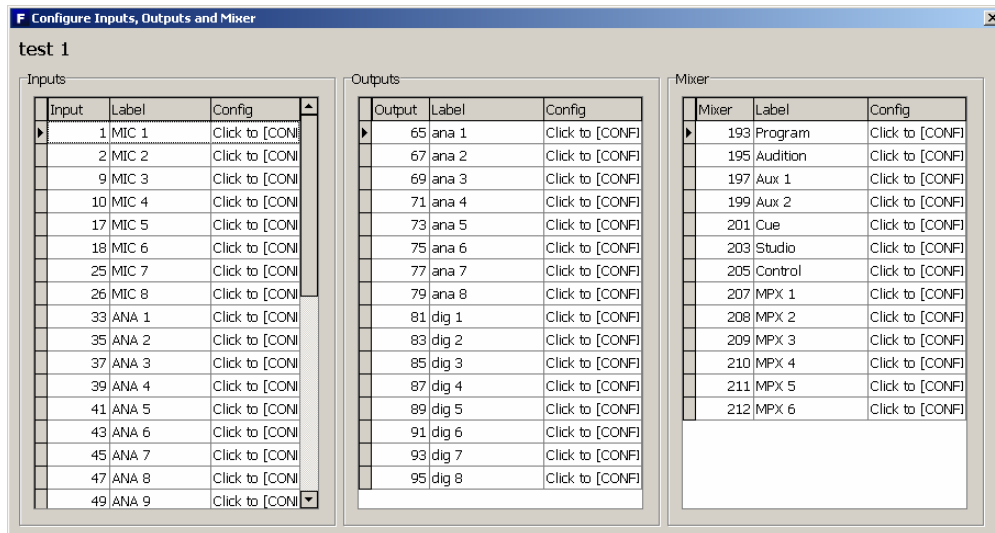

- **“OK”**: allows you to accept the created or edited configuration.
- **“Cancel”**: allows you to reject the created or edited configuration. No change you may have made is saved.

#### 4.3.5.1. Advanced configuration of inputs.

Within the “Configure Inputs, Outputs and Mixer” advanced configuration screen, the left part of the screen shows the complete list of all the available audio input channels. Three columns are shown:

- **“Input”**: shows the internal numeric identifier for the input.
- **“Label”**: shows the name or label associated to the channel.
- **“Config”**: allows you to configure the associated options for that input channel from a specific screen. You can access by clicking **“Click to [CONFIG]”** and then clicking again on the  button that will appear.

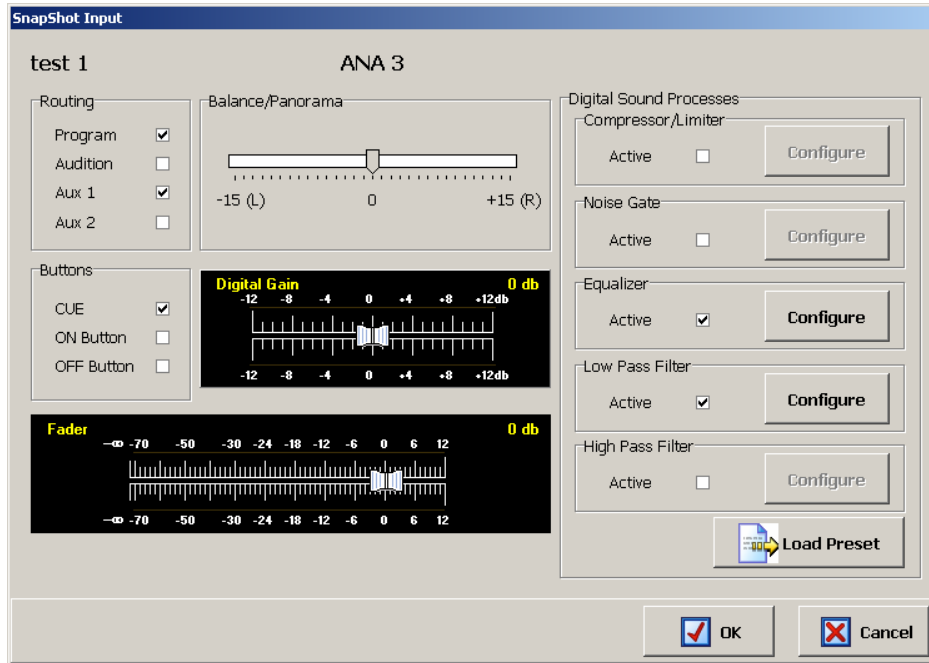

From left to right and from top to bottom the available options are:

- Name of the snapshot (test 1 in the example).
- Name of the channel (ANA 3 in the example).
- **“Routing”**: allows you to configure the initial activation (or not) of the quick routing keys that are available above each fader channel of AEQ FORUM control surface.
- **“Balance/Panorama”**: allows you to manage the initial balance or panoramic control for this input channel.
- **“Buttons”**: allows you to configure the initial status of the PFL sending button (**“CUE”**) and the CHANNEL ON/OFF keys of AEQ FORUM control.
- **“Digital Gain”**: allows you to control the initial input gain of the selected channel from -12dB to +12 dB, by means of a graphical representation of a sliding fader.
- **“Fader”**: allows you to configure the initial virtual position of that channel fader. **IMPORTANT NOTE**: This configuration will take effect when that channel is not associated to a physical fader in the control surface; when it’s associated to a fader, the value corresponding to that physical fader position will be taken.
- When you move the corresponding fader in the control surface, that initial value updates.
- **“Digital Sound Processes”**: allows you to configure and activate/deactivate initially the available processes for that channel or, by means of **“Load Preset”** button, to select and load a previously created preset (see section 4.3.4).
- **“OK”**: allows you to accept the created or edited configuration.
- **“Cancel”**: allows you to reject the created or edited configuration. No change you may have made is saved.

#### 4.3.5.2. Advanced configuration of outputs.

Within the “Configure Inputs, Outputs and Mixer” advanced configuration screen, the central part of the screen shows the complete list of all the available audio output channels. Three columns are shown:

- **“Output”**: shows the internal numeric identifier for the output.
- **“Label”**: shows the name or label associated to the channel.
- **“Config”**: allows you to configure the associated options for that output channel from a specific screen. You can access by clicking **“Click to [CONFIG]”** and then clicking again on the  button that will appear.

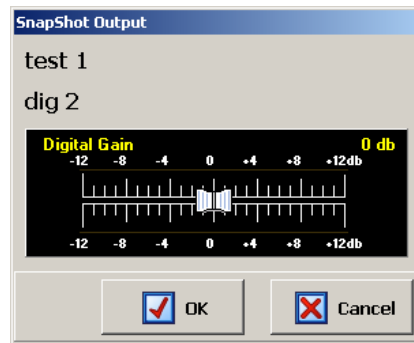

From left to right and from top to bottom the available options are:

- Name of the snapshot (test 1 in the example).
- Name of the channel (dig 2 in the example).
- **“Digital Gain”**: allows you to control the output gain of the selected channel from -12dB to +12 dB, by means of a graphical representation of a sliding fader.
- **“OK”**: allows you to accept the created or edited configuration.
- **“Cancel”**: allows you to reject the created or edited configuration. No change you may have made is saved.

#### 4.3.5.3. Advanced configuration of internal summing buses.

Within the “Configure Inputs, Outputs and Mixer” advanced configuration screen, the right part of the screen shows the complete list of all the available internal summing buses. Three columns are shown:

- **“Mixer”**: shows the internal numeric identifier for the summing bus.
- **“Label”**: shows the name or label associated to the summing bus.
- **“Config”**: allows you to configure the associated options for that summing bus from a specific screen. You can access by clicking **“Click to [CONFIG]”** and then clicking again on the  button that will appear.

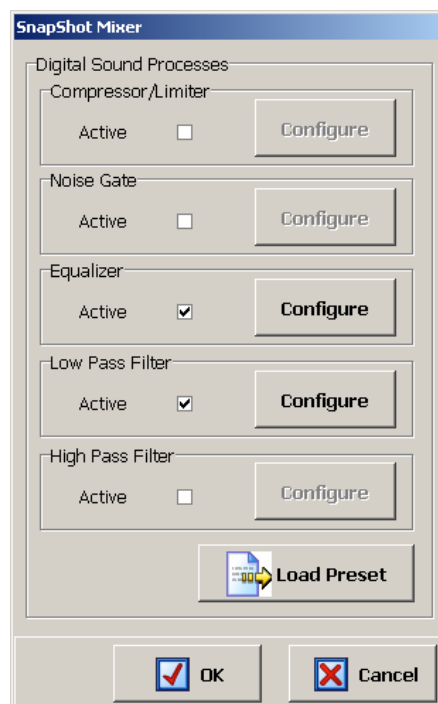

The window that appears will allow you to configure and activate/deactivate the available processes for that channel or, by means of **“Load Preset”** button, to select and load a previously created preset (see section 4.3.4).

#### 4.4. “Firmware Upgrade” menu.

This menu allows you to update the firmware versions for the AEQ FORUM, allowing for the implementation of new features and developments in future versions. Clicking on the “Firmware Upgrade” section on the main screen, the left side of the screen will show you the list of submenus, which includes:

- **“Tree View”**: provides a global view of the system, providing information regarding the currently installed firmware versions for each of the integrated and optional modules that AEQ FORUM mixing console contains.
- **“Upgrade View”**: shows information regarding the system functional module to be updated and the overall progress of the Firmware Upgrade operation.
- **“Log View”**: log containing all the actions associated with an upgrade process.

**IMPORTANT NOTE:** Any operation in this “Firmware Upgrade” section of the Forum Setup application should only be accomplished by qualified personnel in possession of all necessary technical information relative to this system and with the possibility to establish a direct communication with AEQ's technical support (sat@aeq.es).

In order to execute this menu available options, it is necessary that the Forum Setup application is in direct communication with the AEQ FORUM mixer, through one of the 2 Ethernet ports. In case there is no connection to console, the associated submenus will be shown blank.

##### 4.4.1. “Tree View” submenu.

“Tree View” submenu is accessed, from the drop-down menu “Firmware Upgrade”, by clicking on the icon:

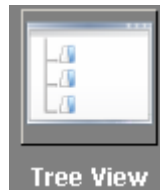

“Tree View” submenu provides a global view of the system, with a tree structured diagram, providing information regarding the currently installed firmware versions for each of the integrated and optional modules that AEQ FORUM mixing console contains.

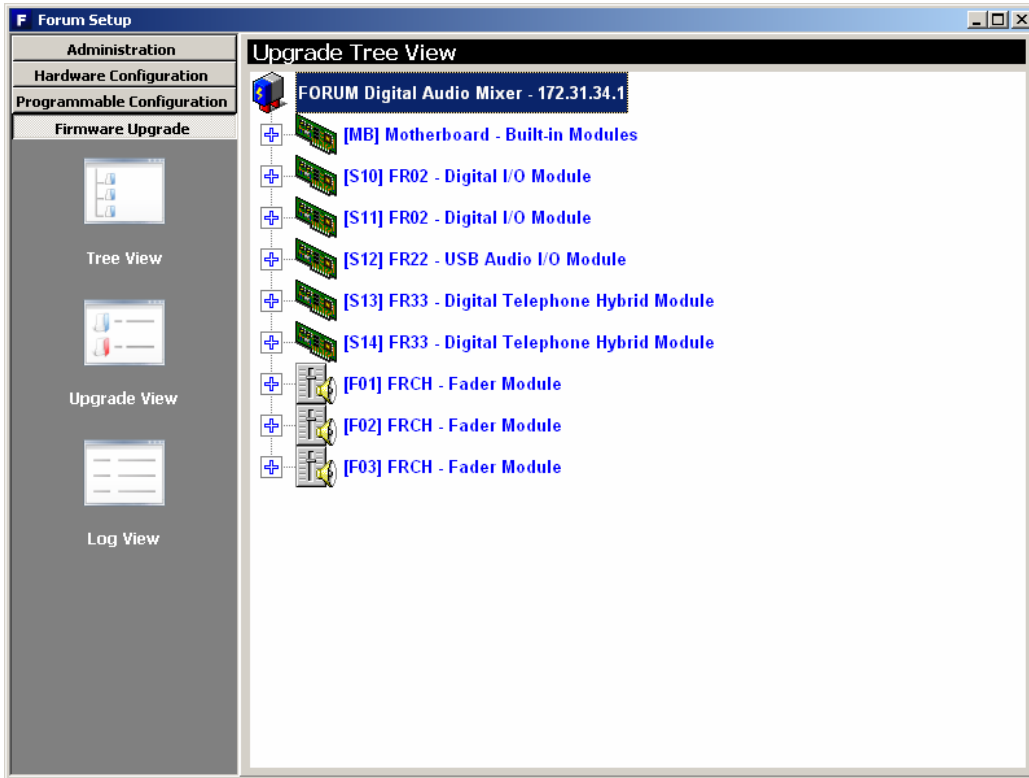

Selecting any of the modules, the associated firmware information will be shown.

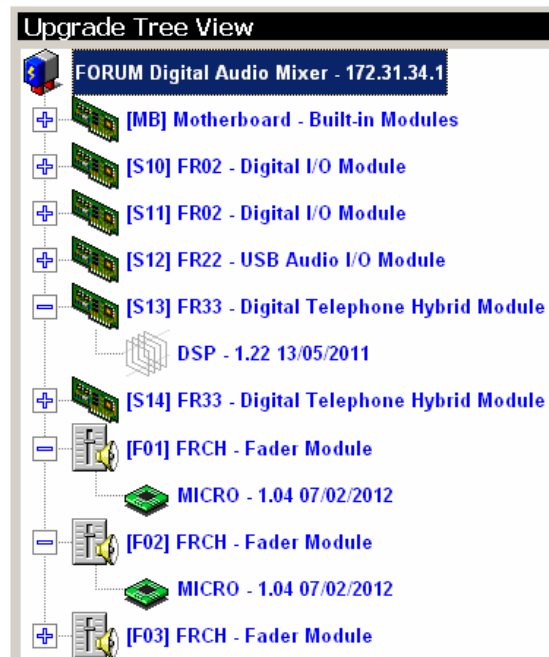
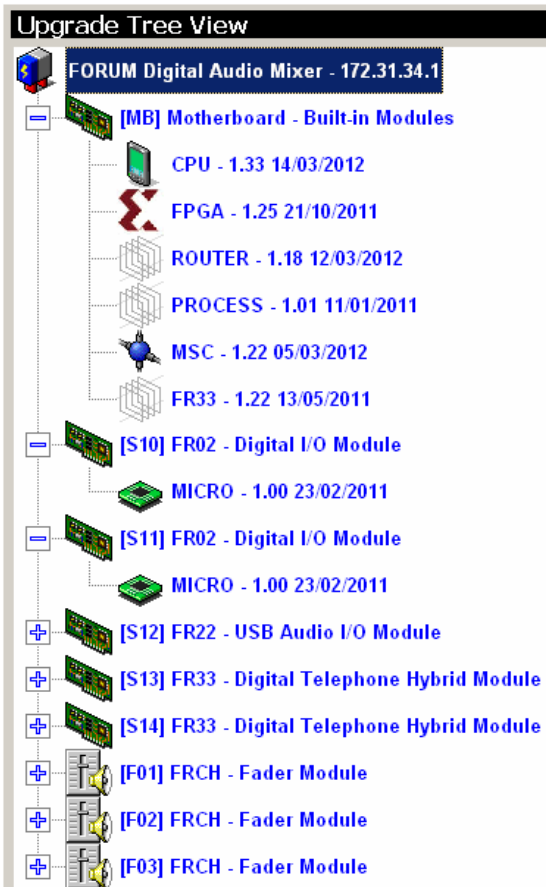

The procedure to upgrade a module firmware is as follows:

1. Place the pointer on the module to be upgraded, press the right mouse button and then the “Upgrade” option that appears.

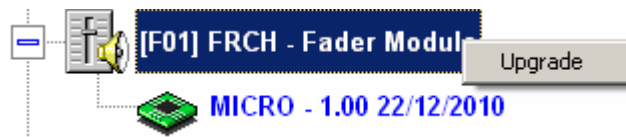

2. In the new window that appears, press the [...] button and select the “AFU” upgrading file (AEQ Firmware Upgrade) that contains the new version you want to load.

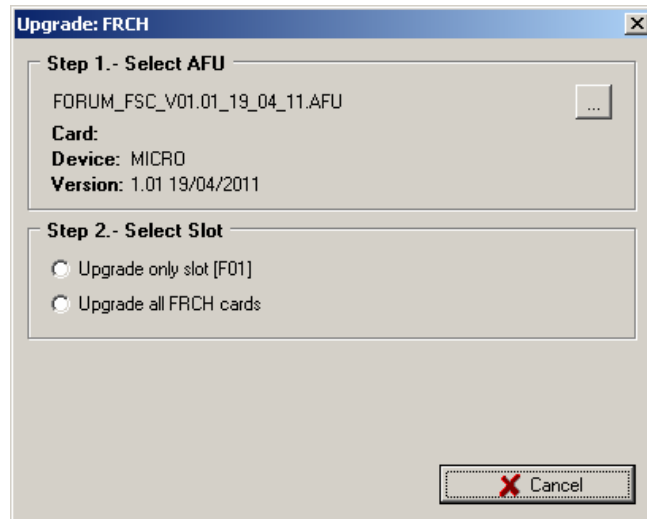

In case you select an AFU file that does not correspond to the selected module, an error message will be displays:



3. Select one of the two options presented: upgrade only one module or all the modules of the same type. Then press “Send” button to start the upgrading process.

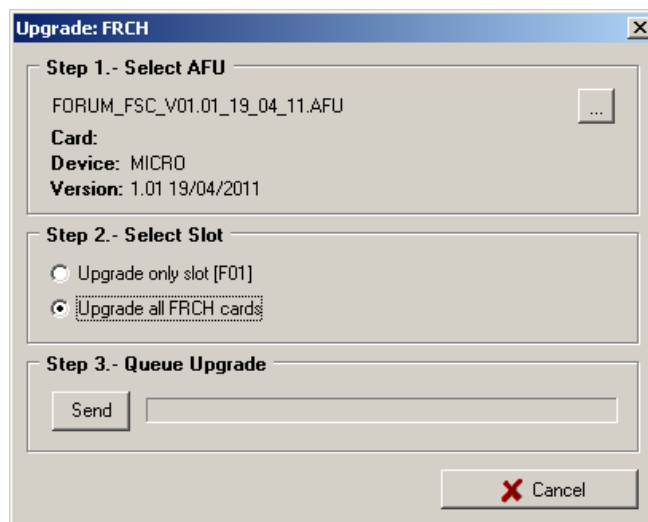

- From this point on, the application changes automatically to “**Upgrade View**” screen in order to show you the upgrading progress. See section 4.4.2 of this manual.

**IMPORTANT NOTE:** You should not act on the system and you must never turn off the equipment during the upgrading process, since this action may deprogram the module that you are trying to upgrade. The **firmware upgrade right order** is: **FRCH module/s**, **MSC module** and **BASE PBA** (FPGA, DSP Process, DSP Router and CPU). The **FR33** telephone hybrid modules will appear as an upgradable module inside the base board (as well as independent modules) and will be upgraded from here.

#### 4.4.2. “Upgrade View” submenu.

“Upgrade View” submenu is accessed, from the drop-down menu “Firmware Upgrade”, by clicking on the icon (although the application will change automatically to this submenu when an firmware upgrading is in process):

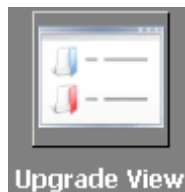

“Upgrade View” submenu allows you to check in real time the upgrading progress.

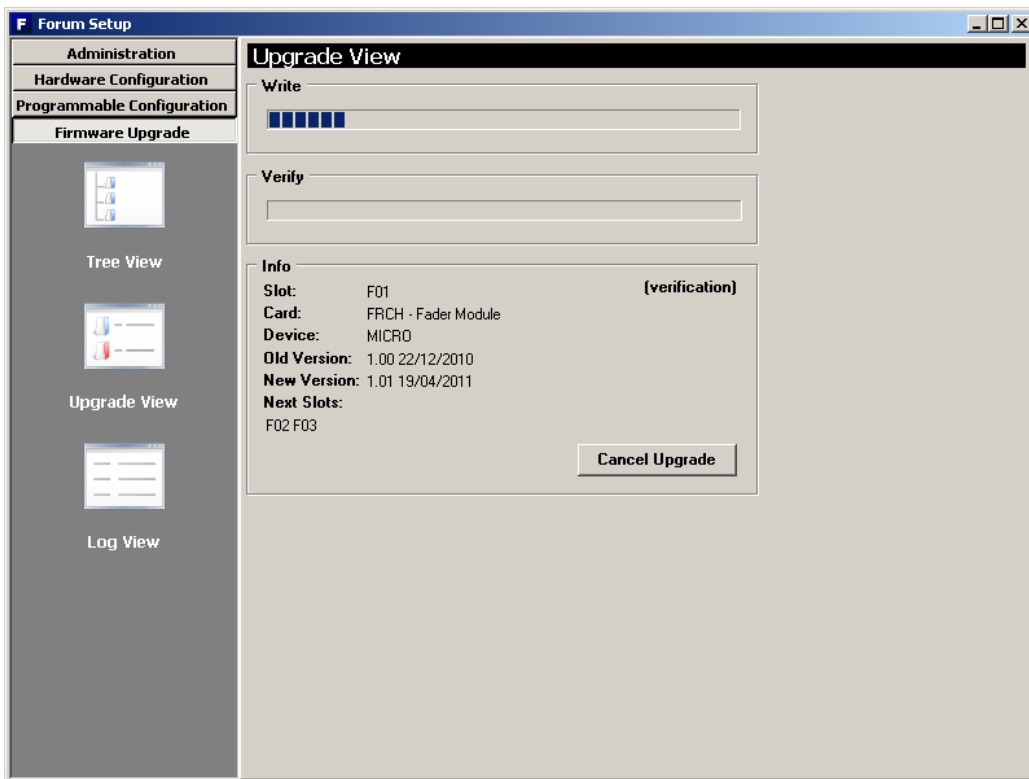

The following fields are visible on screen:

- **“Write”**: progress bar concerning the AFU file copy process from the computer that is running Forum Setup application to the AEQ FORUM internal memory.
- **“Verify”**: progress bar for the AFU file check previously copied to the AEQ FORUM internal memory.
- **“Info”**: displays information about the functional module of the AEQ FORUM subject to the firmware upgrade:



- **“Slot”**: identifies the physical location of the module to be upgraded. In the case of a module placed at the rear panel of the AEQ FORUM, the slot where it is placed will be shown (S13 for instance). In case of a FRCH 4 faders module, its position will be shown (F01, F02 or F03). In case of a base board module, MB (Mother Board) indication will be shown.
- **“Card”**: shows the type of the functional module that is subject to the firmware upgrade.
- **“Device”**: electronic component part of the functional module that will be upgraded.
- **“Old Version”**: information regarding the old firmware version installed on the component.
- **“New Version”**: information about new firmware version installed on the component.
- **“Next Slots”**: indicates the position of the following functional modules to be upgraded.

#### 4.4.3. “Log View” submenu.

“Log View” submenu is accessed, from the drop-down menu “Firmware Upgrade”, by clicking on the icon:

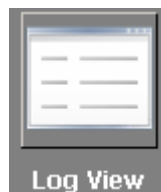

“Log View” submenu represents the record containing all the actions associated with a particular upgrade process as a sequence of independent events chronologically ordered and its specific status (OK or ERROR). This information is complementary information to “Tree View” and “Upgrade View” submenus.

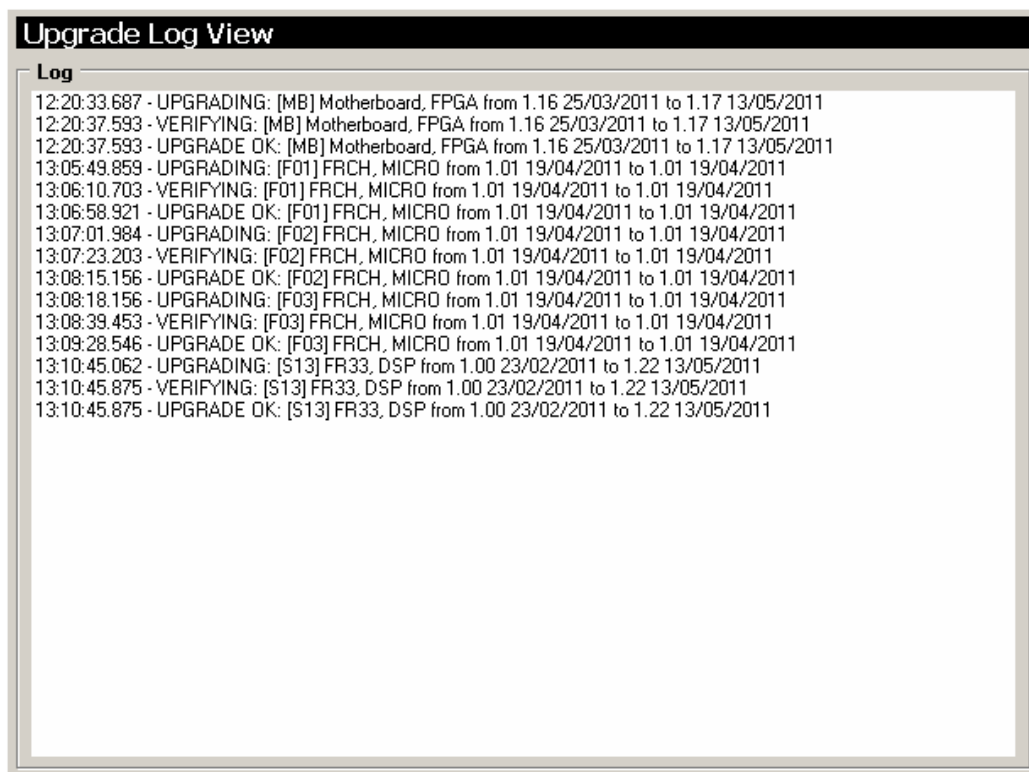

## **5. A.E.Q. GUARANTEE.**

AEQ warrants that this product has been designed and manufactured under a certified Quality Assurance System and according to the ISO 9001/2002 Standard. AEQ therefore warrants that the necessary test protocols to assure the proper operation and the specified technical characteristics of the product have been followed and accomplished. This includes that the general protocols for design and production and the particular ones for this product are conveniently documented.

1.- The present guarantee does not exclude or limit in any way any legally recognized right of the client.

2.- The period of guarantee is defined to be twelve natural months starting from the date of purchase of the product by the first client. To be able to apply to the established in this guarantee, it is compulsory condition to inform the authorized distributor or –to its effect- an AEQ Sales office or the Technical Service of AEQ within thirty days of the appearance of the defect and within the period of guarantee, as well as to facilitate a copy of the purchase invoice and serial number of the product.

It will be equally necessary the previous and expressed conformity from the AEQ Technical Service for the shipment to AEQ of products for their repair or substitution in application of the present guarantee. In consequence, return of equipment that does not comply with these conditions will not be accepted.

3.- AEQ will at its own cost repair the faulty product once returned, including the necessary labour to carry out such repair, whenever the failure is caused by defects of the materials, design or workmanship. The repair will be carried out in any of the AEQ authorized Technical Service Centre. This guarantee does not include the freight charges of the product to or from such Authorized Technical Service Centre.

4.- No Extension of the Guarantee Period for repaired product shall be applied. Nor shall a Substituted Products in application of this Guarantee be subject to Guarantee Period Extension.

5.- The present guarantee will not be applicable in the following situations:  
Improper use or Contrary use of the product as per the User or Instruction Manual; violent manipulation; exhibition to humidity or extreme thermal or environmental conditions or sudden changes of such conditions; electrical discharges or lightning; oxidation; modifications or not authorized connections; repairs or non-authorized disassembly of the product; spill of liquids or chemical products.

6.- Under no circumstances, whether based upon this Limited Guarantee or otherwise, shall AEQ, S.A. be liable for incidental, special, or consequential damages derived from the use or from the impossibility of using the product.

AEQ shall not be liable for loss of information in the disks or data support that have been altered or found to be inexact, neither for any accidental damage caused by the user or other persons manipulating the product.